

BRRENNL

CUSTOM WOOD MOULDINGS & DOORS



**NEW
LAUNCH**

**TURN TO
PAGE 122**



Revolutionary

WOOD-ALTERNATIVE

Exteriors | Interiors

- ✓ Limited Lifetime Warranty*
- ✓ Water-Resistant
- ✓ Paint or Stain
- ✓ Wide Range of Usage
- ✓ Thermoformable
- ✓ Sustainable



SCAN TO KNOW MORE

A percentage of FROGBOARD sales will be donated to protect local Frog habitats.

For over 30 years, Brenlo Custom Wood Mouldings & Doors has been the wood moulding supplier of choice among Luxury Custom Home Builders, Architects, and Designers. We have built a reputation in the industry for being passionate about quality.

This superior quality begins in our grinding room with our hand-cut knives made from top-quality carbide steel. Our knives are then moved to our state-of-the-art moulders where our operators only use kilned dried FAS lumber at a rate of 22 knife cuts per inch. The combination of expertly cut knives, quality rough lumber, and cuts per inch results in a smooth finish, free from chatter marks. After a strict defecting program at the end of the milling process, all material is transferred to our distribution facility, where quantities are confirmed, and additional quality checks are completed. Our end result is a wood moulding that has 99% usage and requires minimal preparation for painting or staining.

With just under 200,000 SQ.FT. of distribution and manufacturing space, Brenlo keeps an expansive in-stock inventory of trim, doors, and plywood to provide customers with the solution needed to complete a project "Right and On Time." Should our stock options not meet the requirements, our in-house CAD team can create and design any trim or door style required. Brenlo currently holds over 10,000 custom profiles for customers and ensures that custom orders are maintained in our library. Therefore, if the product is needed again, it is as simple as referencing the job name. Our advancements in manufacturing allow us to turn custom trim requirements around in 2 weeks and custom doors in 4-5 weeks.

At Brenlo, our company philosophy has always been "The easiest to do business with." This statement resonates with every employee, and we look forward to providing you with the best quality product supported by exceptional customer service.

A handwritten signature in black ink, appearing to read "Fraser Adams". The signature is fluid and cursive, with a long horizontal stroke at the end.

Fraser Adams
President at Brenlo

INDEX

Stock Profile List by Page	4 - 11
Conversion Chart	125
Dressed Four Sides (D4S)	12
Jamb's	12

MOULDING PROFILES

Casings	13
One-Piece Quick Install Casing	18
Backbands	20
Casing & Backband Combinations	25
Baseboards	29
Plinth Blocks	39
Two-Piece Plinth Blocks	41
Door Stops / Base Shoe	42
Moulding Combinations	44
Window Stools	62
Bolections & Aprons	63
Window Stool & Apron Combinations	65
Crown Moulds	66
Cove Moulds	71
Cap Moulds	71
Ceiling & Beam Combinations	72
Panel Moulds Inset	73
Panel Moulds Raised	77
Base Caps	78
Bed Moulds & Quarter Rounds	79
Astragals, Battens, Fascias, Window Mullions	79
Shingle Moulds	80
Chair Rail	81
Glass Beads, Shelf Edges, & Corner Guards	82

DOORS, HARDWARE, SHEET GOODS, ETC.

MDF Beadboard	83
Tongue & Groove Panelling	84
Inspire Series	86
Panelling Details	88
Specialty Items	90

MDF & Finger Joint Profiles	93
Doors	94
Silver Series	95
Stock Shaker	97
Stock Slab	99
Stock Carrara	100
Classic Non-stock	101
Transitional Non-stock	105
Modern Non-stock	109
French Non-stock	115
Door Hardware	117
Plywood	118
Sheet Goods	120
Decking	121
FROGBOARD [®]	122
Exterior Trim Board	124
Novawood	125
Brenlo Custom Shop	128
Wood Species	130
Environmental Commitment	131
Services We Offer	132
Ordering Information	133



HEAD OFFICE

T 416.749.6857 F 416.749.8969 T/F 877.816.6607

Showroom Hours: Monday - Friday 7:30am to 4:30pm

www.brenlo.com

STOCK PROFILE LISTING BY PAGE

CASING		Page
1	3/4" x 2-3/4"	13
1A	3/4" x 3-1/2"	13
4	7/8" x 3"	13
7	3/4" x 3-1/2"	13
7A	3/4" x 2-3/4"	13
11	3/4" x 3-1/2"	13
19	3/4" x 4-1/4"	13
20	3/4" x 2-3/4"	14
20B	3/4" x 3-1/2"	14
22	3/4" x 3-1/2"	14
23	3/4" x 3-1/16"	14
25A	3/4" x 3-1/2"	14
25S	3/4" x 2-1/2"	14
101	3/4" x 3-1/2"	15
102	3/4" x 3-1/2"	15
103	3/4" x 3-1/2"	15
106	3/4" x 3-1/2"	15
106A	3/4" x 2-3/4"	15
106GR	3/4" x 3-1/2"	15
413	3/4" x 3-1/2"	16
414	1" x 3-1/2"	16
415	3/4" x 3-1/2"	16
416	5/8" x 3"	16
420	3/4" x 2-1/2"	16
700	7/8" x 3-1/2"	17
700B	7/8" x 3"	17
800	7/8" x 3-1/2"	17
810	3/4" x 3-1/2"	17
888	3/4" x 2-3/4"	17
2000	11/16" x 3-1/8"	17
2005	5/8" x 2-5/8"	18
2010	1" x 4-1/2"	18
2015	3/4" x 3-1/2"	18
2100	1-5/16" x 4-1/2"	18
2108	1-5/16" x 4-1/2"	18
ONE-PIECE QUICK INSTALL		Page
106S	1-1/16" x 4-1/32"	19
400S	1-1/16" x 4"	19
500	1-1/8" x 3"	19
600	1-1/8" x 3"	19
BACKBAND		Page
30	1-5/8" x 1-5/8"	20
32A	1-1/4" x 2-1/32"	20
33	1-3/4" x 1-7/8"	20
33A	1-5/8" x 1-11/16"	20
34	3/4" x 1-3/8"	21
34ext	3/4" x 1-1/2"	21
35	7/8" x 1-5/8"	21
35ext	7/8" x 1-3/4"	21

STOCK PROFILE LISTING BY PAGE

36	1-3/32" x 1-5/8"	21
37	3/4" x 1-5/16"	21
38	13/16" x 1-3/8"	22
39	7/8" x 1-1/2"	22
40	13/16" x 1-1/4"	22
701	1-1/8" x 1-1/2"	22
BASEBOARD		Page
25B	3/4" x 5-1/2"	29
25C	3/4" x 7-1/4"	29
42	3/4" x 4-1/2"	29
42A	3/4" x 6-1/2"	29
42B	3/4" x 5-1/2"	29
42C	3/4" x 7-1/4"	29
53	3/4" x 5-1/2"	29
302C	3/4" x 7-1/4"	30
306	3/4" x 7-1/4"	30
307	3/4" x 5-1/2"	30
307C	3/4" x 7-1/4"	30
307E	3/4" x 9-1/4"	30
307GR	3/4" x 7-1/4"	31
308	3/4" x 8-1/2"	31
309	3/4" x 8-1/2"	31
310	13/16" x 8-1/2"	32
311	3/4" x 7-1/4"	32
311A	3/4" x 5-1/2"	32
313	3/4" x 7-1/4"	33
314	3/4" x 5-1/2"	33
315	3/4" x 7-1/4"	33
316	5/8" x 5"	34
320	3/4" x 4-1/2"	34
320C	3/4" x 7-1/4"	34
349	3/4" x 5-1/2"	35
349A	3/4" x 4-7/8"	35
349B	3/4" x 7-1/4"	35
352	3/4" x 6-1/2"	36
352B	3/4" x 7-1/4"	36
353B	3/4" x 7-1/4"	35
354	3/4" x 7-1/4"	35
358	3/4" x 5-1/2"	36
820	3/4" x 7-1/4"	36
900	7/8" x 5-1/2"	37
900C	7/8" x 7-1/4"	37
900D	7/8" x 8-1/2"	37
910	13/16" x 9-1/4"	37
2051C	7/8" x 7-1/4"	38
2051D	7/8" x 8-1/2"	38
2053D	1" x 8-1/2"	38
2140	3/4" x 8-1/2"	37
2148	13/16" x 9-1/4"	38

STOCK PROFILE LISTING BY PAGE

703	1-3/4" x 1-1/2"	23
704	7/8" x 1-5/16"	23
713	13/16" x 1-1/4"	23
2001	1-13/16" x 2-3/4"	23
2006	1-5/16" x 2-1/4"	24
2011	1-5/16" x 2-1/8"	24
2016	1-3/4" x 1-1/2"	24

PLINTH BLOCK Page

337-4.5	3/8" x 20" x 4-1/2"	92
337-375	1-3/8" x 20" x 3-3/4"	92
338	1-3/4" x 4-3/8"	39
735	1-15/16" x 4-7/16"	39
736	1-9/16" x 4-13/32"	39
2002	2-1/4" x 5-1/2"	39
2007	11/16" x 4-5/8"	39
2012	2" x 5-5/8" 2pc	41
2013	1-9/16" x 4-3/8"	40
2017	2" x 4-7/8" 2pc	41
2030	1-3/4" x 4-3/8"	40
2030B	1-3/4" x 5-1/8"	40
2130	1-1/2" x 4-7/8"	40

CORNER BLOCK Page

65	7/8" x 3" x 3"	91
66	1" x 4-1/2" x 4-1/2"	91
66A	1" x 3-3/4" x 3-3/4"	91
67	1-3/8" x 4-1/2" x 4-1/2"	91
68	1-5/16" x 3" x 3"	91

CROWN Page

70	3/4" x 5-1/4"	66
70B	3/4" x 7"	66
70C	7/8" x 8-1/2"	66
71	3/4" x 4-1/4"	66
72	3/4" x 3-1/2"	66
72B	3/4" x 4-1/4"	66
72C	3/4" x 5-1/4"	66
73	3/4" x 6-1/4"	67
94	3/4" x 3-1/2"	51
94B	1" x 4-15/16"	51
507	7/8" x 5-1/2"	67
509	7/8" x 3-11/16"	67
523	3/4" x 2-3/8"	68
535	3/4" x 3-1/2"	68
552	13/16" x 5-3/16"	68
573	1-1/4" x 5-1/2"	69
577	1-5/6" x 6-7/8"	69
578	1" x 4-3/4"	69
2150	7/8" x 6-1/2"	70
2156	7/8" x 6-1/2"	70

STOCK PROFILE LISTING BY PAGE

BOLECTION Page

82	1 3/4" x 4"	63
83	1-5/8" x 5-1/2"	63
663	1-5/8" x 5-1/2"	64

APRON Page

81	1-5/16" x 3-1/4"	63
85	1-5/16" x 3-1/4"	63
88	1-1/4" x 3-1/4"	63
89	1-5/16" x 3-1/4"	63

ARCHITRAVE Page

331	1-1/4" x 2-11/16"	91
332	1-3/4" x 2-3/4"	90
L1	1-3/4" x 4-3/4"	90

COVE Page

90	1/2" x 1/2"	71
91	3/4" x 3/4"	71
92	1" x 1"	71
93	3/4" x 1-3/4"	71
94	3/4" x 3-1/2"	71
94B	1" x 4-15/16"	71
95	5/8" x 5/8"	71

CAP MOULDS Page

97	9/16" x 1-1/8"	71
98	13/16" x 1-3/4"	71

DOOR STOPS Page

108	7/16" x 1-5/8"	42
109	7/16" x 1-1/2"	42
110	3/8" x 1-3/8"	42
111	7/16" x 1-3/4"	42
112	3/8" x 1-1/2"	42
112A	3/8" x 1-3/4"	42
113	7/16" x 1-3/4"	42
114	3/8" x 1-1/2"	42
116	7/16" x 1-3/4"	42
117	1/2" x 2-1/2"	43

PANEL MOULDS & BASE CAPS Page

118	7/16" x 3/4"	73
119	1/2" x 1-1/16"	73
121	11/16" x 1-3/8"	78
122	5/8" x 1-9/16"	73
122A	7/16" x 1-1/8"	73
122B	3/4" x 2-3/16"	73
123	9/16" x 1-3/4"	78
124	3/4" x 2-1/4"	73
125	1-1/16" x 1-1/2"	78
126	1/2" x 1-5/8"	74
129	3/8" x 1"	74

STOCK PROFILE LISTING BY PAGE

130	1" x 1-1/4"	77
130S	7/8" x 1"	77
131	5/8" x 1"	77
132	1-1/4" x 1-5/8"	77
133	13/16" x 1-3/8"	77
134	3/8" x 11/16"	74
327	1/2" x 1-3/4"	74
328	7/16" x 1-5/16"	74
329	3/8" x 1-1/8"	91
330	5/8" x 2"	91
333	1/2" x 1-1/4"	76
334	7/16" x 1-1/4"	76
335	7/16" x 11/16"	76
336	7/16" x 11/16"	76
607	7/16" x 7/8	74
608	7/16" x 11/16"	74
609	7/16" x 1-1/4"	75
610TL	3/8" x 7/16"	75
611TL	3/8" x 7/16"	75
612TL	3/8" x 7/16"	75
613TL	3/8" x 7/16"	75
620	1/2" x 1-1/4"	75
632	3/4" x 1-1/2"	77

PANEL MOULDS & BASE CAPS Page

645	11/16" x 2-1/2"	75
648	3/4" x 2-1/4"	76
649	3/4" x 1-3/4"	76
651	7/8" x 3"	77
652	7/8" x 3"	77
666	1/2" x 7/8"	76
670	13/16" x 1-1/2"	78
671	1-1/8" x 2"	78

BED MOULD Page

135	5/8" x 2-3/4"	79
136	5/8" x 2-1/4"	79
138	5/8" x 1-5/8"	79

QUATER ROUND Page

141	1" x 1"	79
142	3/4" x 3/4"	79
143	5/8" x 5/8"	79
144	1/2" x 1/2"	79

TONGUE & GROOVE Page

145	3/8" x 3-1/8"	84
145B	1/2" x 5-1/2"	84
145S	3/8" x 3-1/8"	84
146	3/4" x 3-1/2"	84
146A	3/4" x 4-3/4"	84
146B	3/4" x 5-1/2"	84
147B	3/4" x 5-1/2" (1/8" gap)	85
147C	3/4" x 7-1/4" (1/8" gap)	85
148B	3/4" x 5-1/2" (1/2" gap)	85
148C	3/4" x 7-1/4" (1/2" gap)	85

STOCK PROFILE LISTING BY PAGE

INSPIRE SERIES Page

INSP 01	1/2" x 5"	86
INSP 02	1/2" x 5-7/16"	86
INSP 03	3/4" x 6-1/4"	86
INSP 04	3/4" x 7-1/8"	86
INSP 05	3/4" x 8-1/8"	86
INSP 06	3/4" x 8-9/16"	87
INSP 07	3/4" x 8-1/4"	87
INSP 08	3/4" x 7-7/8"	87
INSP 09	3/4" x 8-1/4"	87

BATTEN Page

150	9/16" x 2-1/4"	79
151	3/4" x 1-5/8"	79

SHINGLE MOULD Page

152	1-7/32" x 1-11/16"	80
153	1-5/16" x 2-3/8"	80
154	1-1/4" x 1-3/4"	80
157	3/4" x 1-1/4"	81
158	3/4" x 1-3/4"	81

MULLION Page

162	3/8" x 1-5/8"	80
164-1-1/8	3/8" x 1-1/8"	80
164-1-3/8	3/8" x 1-3/8"	80
165	1/2" x 1-1/2"	80
166	3/8" x 1-1/4"	80

PILASTER Page

171	3/4" x 6"	92
------------	-----------	----

BAR RAIL Page

179	1-3/4" x 5-1/4"	90
------------	-----------------	----

CHAIR RAIL Page

181	1" x 3-5/8"	81
186	3/4" x 3"	81
187	5/8" x 2-1/2"	81
189	1" x 2-1/2"	81
189A	1-5/16" x 2-1/2"	82
2180	7/8" x 3-1/8"	82
2188	13/16" x 3-1/8"	82

GLASS BEAD Page

190	1/2" x 9/16"	82
191	3/8" x 3/8"	82

SHELF EDGE Page

195	3/8" x 3/4"	82
197	1/4" x 3/4"	82

CORNER GUARD Page

200	1-5/16" x 1-5/16"	83
201	1-1/8" x 1-1/8"	83
MCE204	3/4" x 3/4"	90

STOCK PROFILE LISTING BY PAGE

HALF ROUND		Page
205	3/4" x 1-1/2"	91
205A	1" x 2"	91
205B	1-1/4" x 2-1/2"	91
205C	1-1/2" x 3"	91
205D	1-3/4" x 3-1/2"	91
206	1/2" x 1"	91
207	3/8" x 3/4"	91

BASE SHOE		Page
208	1/2" x 3/4"	43
209	1/2" x 7/8"	43
210	1/2" x 3/4"	43
216	1/2" x 1-5/8"	43

ASTRAGAL		Page
211	3/4" x 1-3/4"	80
212	3/4" x 1-3/8"	80
213	7/16" x 3/4"	80
215	1-1/4" x 2-7/16"	80

STOOL		Page
226	1-5/16" x 2-3/4"	62
227	1-5/16" x 2-3/4"	62
228	1-1/16" x 2-1/4"	62
229	1-1/16" x 3-1/4"	62
230	1-1/16" x 4-1/4"	62
231	1-1/16" x 5-1/4"	62
232	1-1/16" x 7-3/4"	62
233	1-5/8" x 2-3/4"	62
234	1-5/16" x 2-3/8"	62
MK	1-3/4" x 3-1/2"	62

PICTURE		Page
225	11/16" x 1-3/4"	90

HANDRAIL		Page
903	1-5/8" x 2-3/4"	92
904	1-5/8" x 2-3/4"	92
930	1/4" x 1-5/16"	92

D4S		Page
D412X2	1/2" x 1-1/2"	12
D412X3	1/2" x 2-1/2"	12
D412X4	1/2" x 3-1/2"	12
D412X6	1/2" x 5-1/2"	12
D4x1	3/4" x 3/4"	12
D41x2	3/4" x 1-1/2"	12
D41x3	3/4" x 2-1/2"	12
D41x4	3/4" x 3-1/2"	12

STOCK PROFILE LISTING BY PAGE

D41x5	3/4" x 4-1/2"	12
D41x6	3/4" x 5-1/2"	12
D41x8	3/4" x 7-1/4"	12
D41x10	3/4" x 9-1/4"	12
D41x12	3/4" x 11-1/4"	12
D4125x4	1-1/4" x 3-1/2"	12
D4125x6	1-1/4" x 5-1/2"	12
D4125x8	1-1/4" x 7-1/4"	12
D42x2	1-1/2" x 1-1/2"	12
D42x4	1-1/2" x 3-1/2"	12
D42x6	1-1/2" x 5-1/2"	12
D42x8	1-1/2" x 7-1/4"	12
D42x10	1-1/2" x 9-1/4"	12
D42x12	1-1/2" x 11-1/4"	12

JAMBS		Page
4.625	3/4" x 4-5/8"	12
4.875	3/4" x 4-7/8"	12
6.625	3/4" x 6-5/8"	12
6.875	3/4" x 6-7/8"	12
5.5Rab	1-1/2" x 5-1/2" rabbeted for 1-3/4" door	12

MDF PROFILES		Page
2700FJP	1" x 3" Stocked In Finger-Joint Pine	93
MDF8031	3/4" x 3-1/2" Casing	93
MDF8954	3/4" x 3-1/2" Casing	93
MDF8095	1/2" x 5-1/4" Baseboard	93
MDF8235	5/8" x 7-1/8" Baseboard	93
MDF8915	1/2" x 7-1/4" Baseboard	93

DRESSED FOUR SIDES (D4S)

CASINGS

Brenlo is one of the largest suppliers of stock & custom D4S. We have an in-stock program of 1/2", 3/4", 1-1/4" & 1-1/2" thicknesses in a wide variety of widths and species.

DRESSED FOUR SIDES SQUARE STOCK:

1/2 x 2 1/2 x 3 1/2 x 4 1/2 x 6

(1/2" x 1-1/2") (1/2" x 2-1/2") (1/2" x 3-1/2") (1/2" x 5-1/2")

1/2" 

1 x 2 1 x 3 1 x 4 1 x 6 1 x 8

(3/4" x 1-1/2") (3/4" x 2-1/2") (3/4" x 3-1/2") (3/4" x 5-1/2") (3/4" x 7-1/4")

1 x 10 1 x 12

(3/4" x 9-1/4") (3/4" x 11-1/4")

3/4" 

5/4 x 4 5/4 x 6 5/4 x 8

(1-1/4" x 3-1/2") (1-1/4" x 5-1/2") (1-1/4" x 7-1/4")

1-1/4" 

2 x 2 2 x 4 2 x 6 2 x 8

(1-1/2" x 1-1/2") (1-1/2" x 3-1/2") (1-1/2" x 5-1/2") (1-1/2" x 7-1/4")

2 x 10 2 x 12

(1-1/2" x 9-1/4") (1-1/2" x 11-1/4")

1-1/2" 

STOCK AVAILABLE SPECIES

D4S W/W Oak Pine Maple Mahog Walnut W.Oak Rift W. Oak NEW

D412X2	1/2" x 1-1/2"
D412X3	1/2" x 2-1/2"	NEW
D412X4	1/2" x 3-1/2"
D412X6	1/2" x 5-1/2"
D41x2	3/4" x 1-1/2"
D41x3	3/4" x 2-1/2"
D41x4	3/4" x 3-1/2"
D41x5	3/4" x 4-1/2"
D41x6	3/4" x 5-1/2"
D41x8	3/4" x 7-1/4"
D41x10	3/4" x 9-1/4"
D41x12	3/4" x 11-1/4"
D4125x4	1-1/4" x 3-1/2"
D4125x6	1-1/4" x 5-1/2"
D4125x8	1-1/4" x 7-1/4"	NEW
D42x2	1-1/2" x 1-1/2"
D42x4	1-1/2" x 3-1/2"
D42x6	1-1/2" x 5-1/2"
D42x8	1-1/2" x 7-1/4"
D42x10	1-1/2" x 9-1/4"
D42x12	1-1/2" x 11-1/4"

JAMBS W/W Oak Pine Maple Mahog Walnut

4.625	3/4" x 4-5/8"
4.875	3/4" x 4-7/8"
6.625	3/4" x 6-5/8"
6.875	3/4" x 6-7/8"
5.5Rab	1-1/2" x 5-1/2"	rabbeted for 1-3/4" door

EDGE BEVELLED WITH RELIEF GROOVES ONE SIDE

BEVELED JAMB STOCK:

3/4" x 4-5/8" For 2 x 4 & 1/2" Drywall

3/4" x 4-7/8" For 2 x 4 & 5/8" Drywall

3/4" x 6-5/8" For 2 x 6 & 1/2" Drywall

3/4" x 6-7/8" For 2 x 6 & 5/8" Drywall

SINGLE RABBETED JAMBS:

1-1/2" X 5-1/2"

(Rabbet size 1/2" X 1-13/16")

For walls up to 5-1/2" wide.

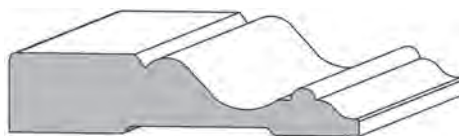

1A - 3/4" (20mm) x 3-1/2" (89mm)

Corresponding Baseboard #42B or #42C

SPECIES: W/W OAK WALNUT

1 - 3/4" (20mm) x 2-3/4" (70mm)

Corresponding Baseboard #42 or #42B

SPECIES: W/W OAK MAPLE PINE

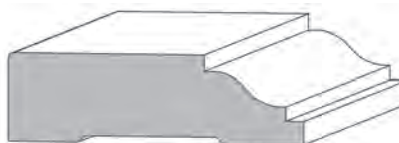

4 - 7/8" (22mm) x 3" (76mm)

Corresponding Baseboard #349 or #53

SPECIES: W/W

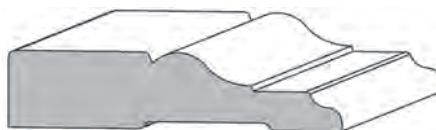

7 - 3/4" (20 mm) x 3-1/2" (89mm)

Corresponding Baseboard #349 or #349B

SPECIES: W/W

7A - 3/4" (20 mm) x 2-3/4" (70mm)

Corresponding Baseboard #349 or #349A

SPECIES: W/W



11 - 3/4" (20mm) x 3 1/2" (89mm)

Corresponding Baseboard #311

SPECIES: W/W EZ BEND



19 - 3/4" (20 mm) x 4-1/4" (120mm)

Corresponding Baseboard #353B

SPECIES: W/W

CASINGS

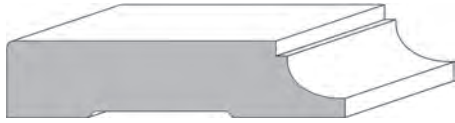

20 - 3/4" (20 mm) x 2-3/4" (70mm)
Corresponding Baseboard #354
SPECIES: W/W PINE

20B - 3/4" (20 mm) x 3-1/2" (89mm)
Corresponding Baseboard #354
SPECIES: W/W



22 - 3/4" (20 mm) x 3-1/2" (89mm)
Corresponding Baseboard #53 or 1 x 8
SPECIES: W/W

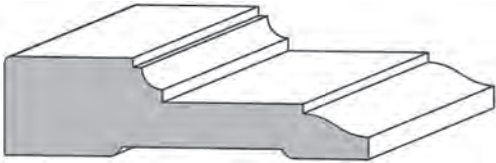

23 - 3/4" (20 mm) x 3-1/16" (78mm)
Corresponding Baseboard #358
SPECIES: W/W

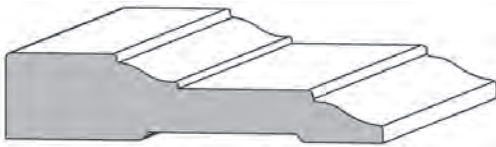

25A - 3/4" (20 mm) x 3-1/2" (89mm)
Corresponding Baseboard #25C
SPECIES: W/W OAK PINE WALNUT

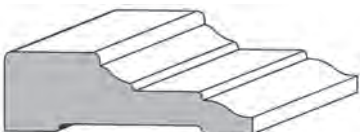

25S - 3/4" (20 mm) x 2-1/2" (64mm)
Corresponding Baseboard #25B
SPECIES: W/W

CASINGS

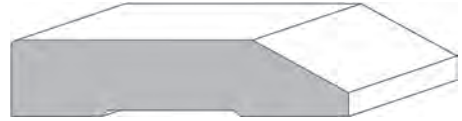

101 - 3/4" (20 mm) x 3-1/2" (89mm)
Corresponding Baseboard #306, #307, #307C
SPECIES: W/W



102 - 3/4" (20 mm) x 3-1/2" (89mm)
Corresponding Baseboard #302C
SPECIES: W/W



103 - 3/4" (20 mm) x 3-1/2" (89mm)
Corresponding Baseboard #306 or D4S 1 x 8
SPECIES: W/W

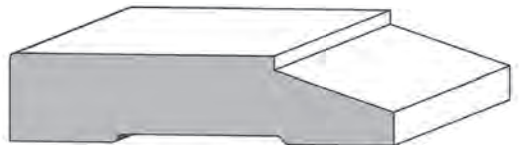

106 - 3/4" (20 mm) x 3-1/2" (89mm)
Corresponding Baseboard #306, #307 or #307c
SPECIES: W/W OAK PINE MAPLE MAHOGANY WALNUT
EZ BEND

106A - 3/4" (20 mm) x 2-3/4" (70mm)
Corresponding Baseboard #307
SPECIES: W/W

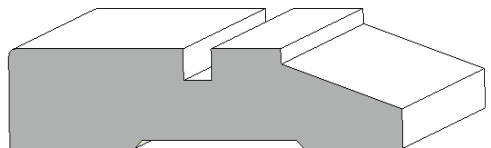

106GR - 3/4" (20 mm) x 3-1/2" (89mm)
Corresponding Baseboard #307GR
SPECIES: W/W

CASINGS

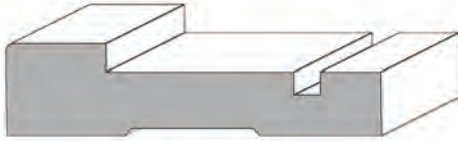

413 - 3/4" (20 mm) x 3-1/2" (89mm)
Corresponding Baseboard: #313
SPECIES: W/W

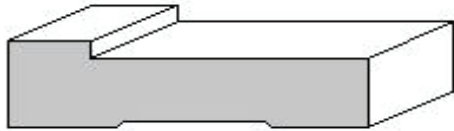

414 - 1" (25 mm) x 3-1/2" (89mm)
Corresponding Baseboard: #314
SPECIES: W/W



415 - 3/4" (20 mm) x 3-1/2" (89mm)
Corresponding Baseboard: #315
SPECIES: W/W

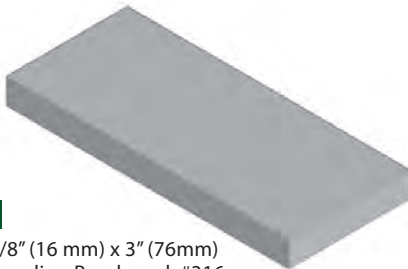

NEW

416 - 5/8" (16 mm) x 3" (76mm)
Corresponding Baseboard: #316
SPECIES: W/W

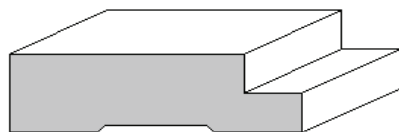

420 - 3/4" (20 mm) x 2-1/2" (64mm)
Corresponding Baseboard: #320
SPECIES: W/W

CASINGS

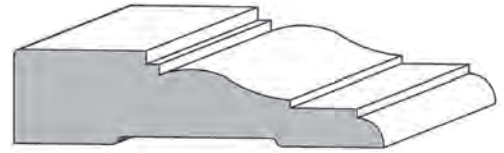

700 - 7/8" (22 mm) x 3-1/2" (89mm)
Corresponding Baseboard #900, #900C, #900D
SPECIES: W/W MAHOGANY WALNUT EZ BEND

700B - 7/8" (22 mm) x 3" (76mm)
SPECIES: W/W



800 - 7/8" (22 mm) x 3-1/2" (89mm)
Corresponding Baseboard #352B
SPECIES: W/W OAK



810 - 3/4" (20 mm) x 3-1/2" (89mm)
Corresponding Baseboard #820
SPECIES: W/W



888 - 3/4" x 2-3/4" (70mm)
Corresponding Baseboard #42B or #349
SPECIES: W/W



2000 - 11/16" (18 mm) x 3-1/8" (79mm)
Corresponding Backband #2001
SPECIES: W/W

CASINGS

ONE-PIECE QUICK INSTALL

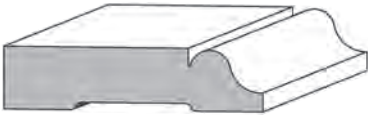

2005 - 5/8" (16 mm) x 2-5/8" (67mm)
Corresponding Backband #2006
SPECIES: W/W

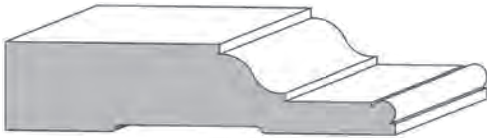

2010 - 1" (25 mm) x 4-1/2" (114mm)
SPECIES: W/W

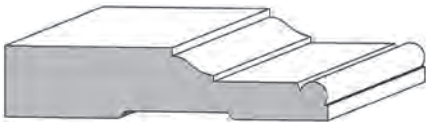

2015 - 3/4" (19 mm) x 3-1/2" (89mm)
SPECIES: W/W



2100 - 1-5/16" (33mm) x 4-1/2" (114mm)
SPECIES: W/W

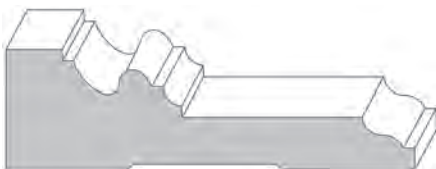

2108 - 1-5/16" (33mm) x 4-1/2" (114mm)
SPECIES: W/W

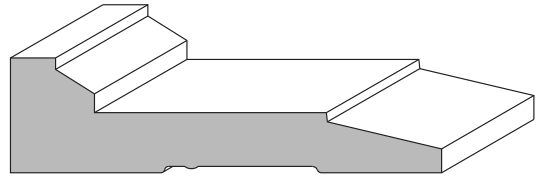

106S - 1-1/16" (27mm) x 4-1/32" (103mm)
SPECIES: W/W

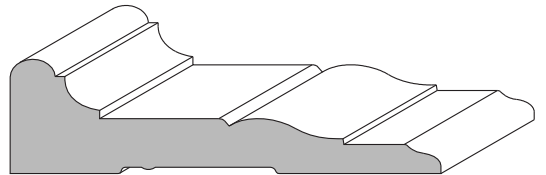

400S - 1-1/16" (27 mm) x 4" (103mm)
SPECIES: W/W

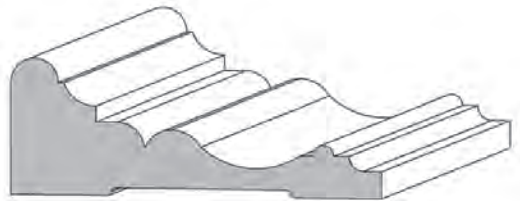

500 - 1-1/8" (29 mm) x 3" (76mm)
Corresponding Baseboard #42B
SPECIES: W/W

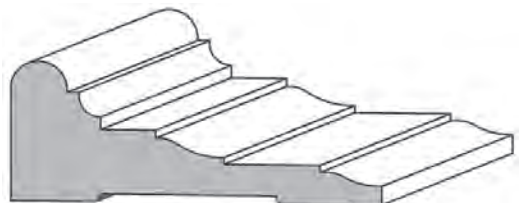

600 - 1-1/8" (29 mm) x 3" (76mm)
Corresponding Baseboard #25B
SPECIES: W/W

BACKBANDS

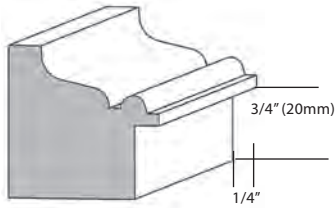

30 - 1-5/8" (41mm) x 1-5/8" (41mm)
Corresponding Casing #20
SPECIES: W/W WALNUT

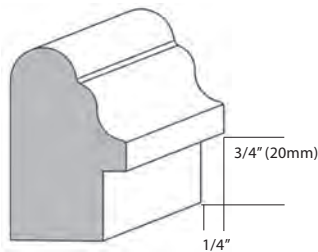

32A - 1-1/4" (32mm) x 2-1/32" (52mm)
Corresponding Casing #1A
SPECIES: W/W

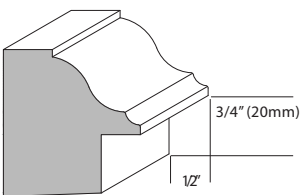

33 - 1-3/4" (44mm) x 1 7/8" (47mm) 3/4" (20mm) Rabbet
Corresponding Casing #102
SPECIES: W/W

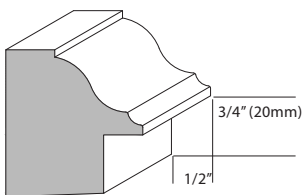

33A - 1-5/8" (41mm) x 1-11/16" (47mm) 3/4" (20mm) Rabbet
Corresponding Casing #102
SPECIES: W/W

BACKBANDS

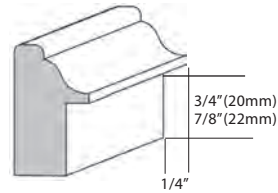

34 - 13/16" (21mm) x 1-3/8" (35mm)
SPECIES: W/W OAK PINE MAPLE WALNUT

34Ext. - 13/16" (21mm) x 1-1/2" (38mm) 7/8" (22mm) Rabbet
SPECIES: W/W

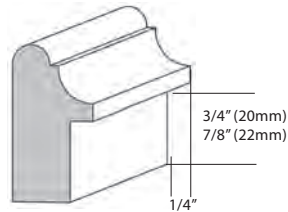

35 - 7/8" (22mm) x 1-5/8" (41mm)
SPECIES: W/W OAK

35Ext. - 7/8" (22mm) x 1-3/4" (44mm) 7/8" (22mm) Rabbet
SPECIES: W/W OAK PINE WALNUT
EZ BEND

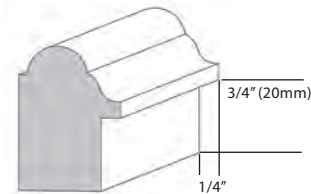

36 - 1-3/32" (28mm) x 1-5/8" (41mm)
Corresponding Casing #7
SPECIES: W/W

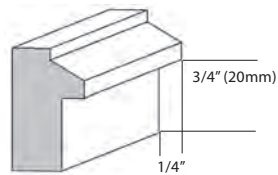

37 - 3/4" (19mm) x 1-5/16" (33mm)
Corresponding Casing #106, #107
SPECIES: W/W OAK PINE MAPLE MAHOGANY WALNUT
EZ BEND

BACKBANDS

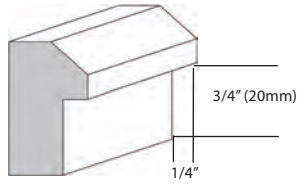

38 - 13/16" (21mm) x 1-3/8" (35mm)
Corresponding Casing #101
SPECIES: W/W

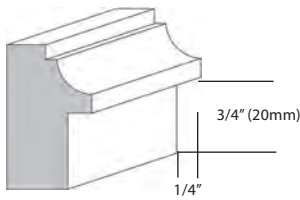

39 - 7/8" (22mm) x 1-1/2" (38mm)
Corresponding Casing #25A
SPECIES: W/W

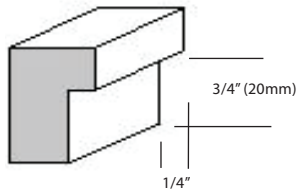

40 - 13/16" (21mm) x 1-1/4" (33mm)
Corresponding Casing #415
SPECIES: W/W

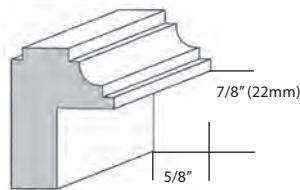

701 - 1-1/8" (29mm) x 1-1/2" (38mm)
Corresponding Casing #700
SPECIES: W/W

BACKBANDS

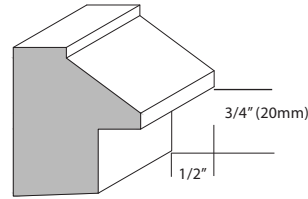

703 - 1-3/4" (44mm) x 1 1/2" (38mm) 3/4" (20mm) Rabbet
Corresponding Casing #106, #107
SPECIES: W/W

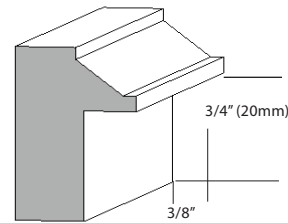

704 - 7/8" (22mm) x 1-5/16" (33mm)
Corresponding Casing #106, #101
SPECIES: W/W

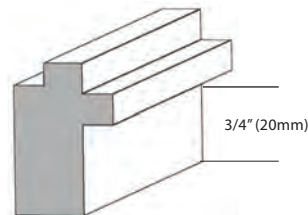

713 - 13/16" (21mm) x 1-1/4" (33mm)
3/4" (20mm) Rabbet
Corresponding Casing #413
SPECIES: W/W

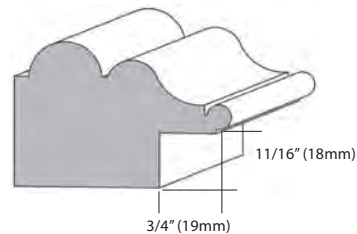

2001 - 1-13/16" (46mm) x 2-3/4" (70mm)
Corresponding Casing #2000
SPECIES: W/W

BACKBANDS

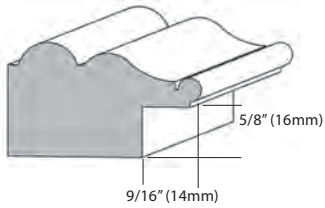

2006 - 1-5/16" (33mm) x 2-1/4" (57mm)
Corresponding Casing #2005
SPECIES: W/W

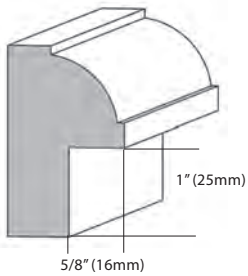

2011 - 1-5/16" (33mm) x 2-1/8" (54mm)
Corresponding Casing #2010
SPECIES: W/W

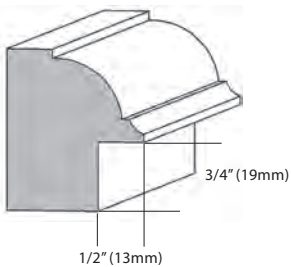

2016 - 1-3/4" (44mm) x 1-1/2" (38mm)
Corresponding Casing #2015
SPECIES: W/W

CASINGS / BACKBAND COMBINATIONS

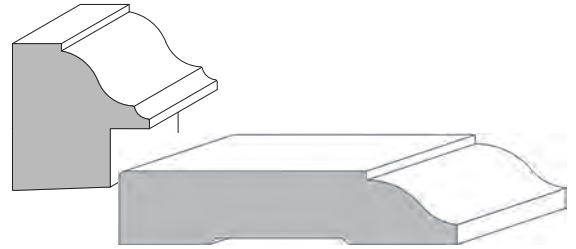

33A - 1-5/8" (41mm) x 1-11/16" (47mm) 3/4" (20mm) Rabbet
102 - 3/4" (20 mm) x 3-1/2" (89mm)
Corresponding Baseboard #302C
33A - SPECIES: W/W
102 - SPECIES: W/W

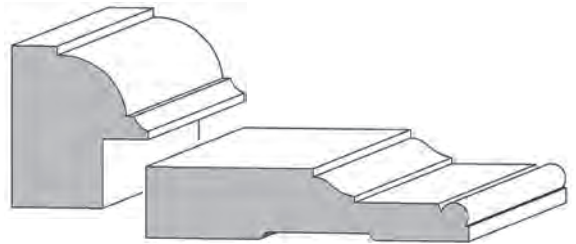

2016 - 1-3/4" (44mm) x 1-1/2" (38mm)
2015 - 3/4" (19 mm) x 3-1/2" (89mm)
Corresponding Baseboard #310
2016- SPECIES: W/W
2015 - SPECIES: W/W

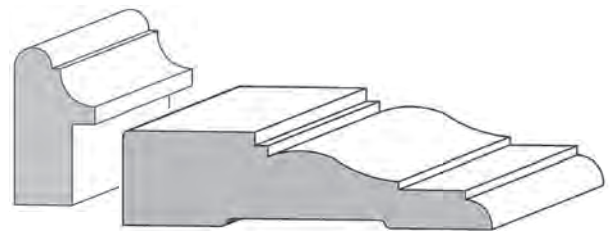

35 - Ext. - 7/8" (22mm) x 1-3/4" (44mm) (22mm) Rabbet
700 - 7/8" (22 mm) x 3-1/2" (89mm)
Corresponding Baseboard #900, #900C, #900D
700B - 7/8" (22 mm) x 3" (76mm)
35-EXT - SPECIES: W/W OAK PINE MAHOGANY WALNUT
EZ BEND
700 - SPECIES: W/W OAK MAPLE MAHOGANY WALNUT
700B - SPECIES: W/W

CASINGS / BACKBAND COMBINATIONS

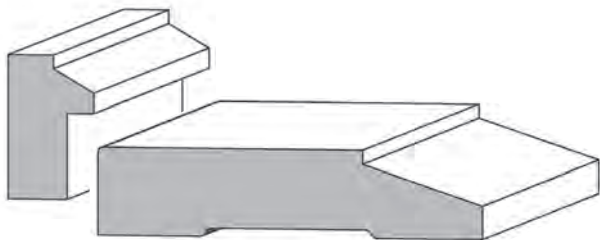

37 - 3/4" (19mm) x 1-5/16" (33mm) (20mm Rabbet)
106 - 3/4" (20 mm) x 3-1/2" (89mm)
 Corresponding Baseboard #306, #307 or #307c
 37 - SPECIES: W/W OAK PINE MAPLE MAHOGANY WALNUT
 EZ BEND
 106 - SPECIES: W/W OAK PINE MAPLE MAHOGANY WALNUT
 EZ BEND

CASINGS / BACKBAND COMBINATIONS

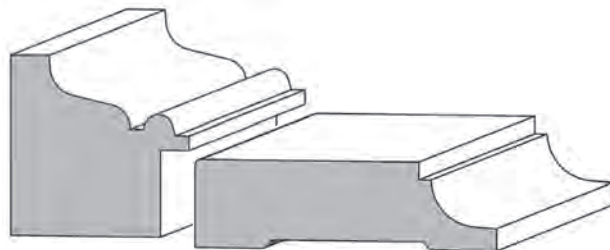

30 - 1-5/8" (41mm) x 1-5/8" (41mm) (20mm Rabbet)
20 - 3/4" (20mm) x 2-3/4" (70mm)
 Corresponding Baseboard #354
 30 - SPECIES: W/W WALNUT
 20 - SPECIES: W/W PINE

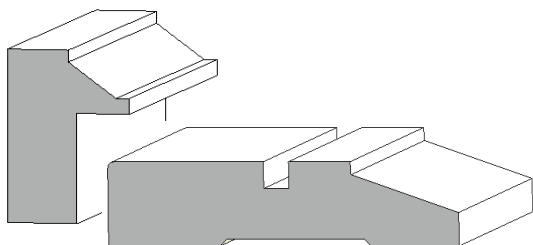

704 - 7/8" (22mm) x 1-5/16" (33mm) 3/4" (20mm) Rabbet
106GR - 3/4" (20mm) x 3-1/2" (89mm)
 Corresponding Baseboard #307GR
 704 - SPECIES: W/W
 106GR - SPECIES: W/W

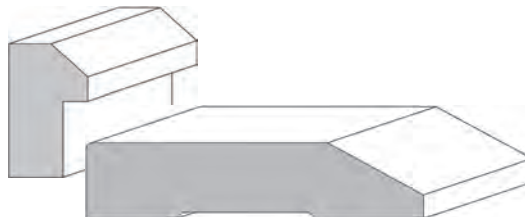

38 - 13/16" (21mm) x 1-3/8" (35mm)
101 - 3/4" (20 mm) x 3-1/2" (89mm)
 Corresponding Baseboard #306, #307, #307C
 38 - SPECIES: W/W
 101 - SPECIES: W/W

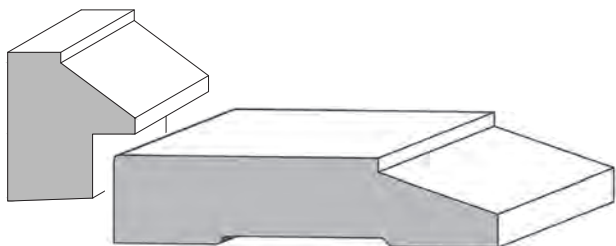

703 - 1-3/4" (44mm) x 1 1/2" (38mm) 3/4" (20mm) Rabbet
106 - 3/4" (20 mm) x 3-1/2" (89mm)
 Corresponding Baseboard #307C, #307
 703 - SPECIES: W/W
 106 - SPECIES: W/W OAK PINE MAPLE MAHOGANY WALNUT

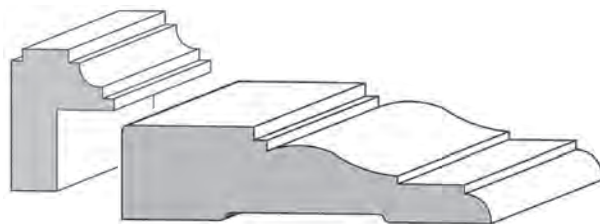

701 - 1-1/8" (29mm) x 1-1/2" (38mm)
700 - 7/8" (22 mm) x 3-1/2" (89mm)
 Corresponding Baseboard #900, #900C, #900D
700B - 7/8" (22 mm) x 3" (76mm)
 701 - SPECIES: W/W
 700 - SPECIES: W/W OAK MAPLE MAHOGANY WALNUT
 700B - SPECIES: W/W

CASINGS / BACKBAND COMBINATIONS

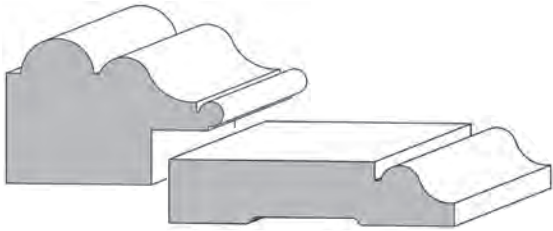

2001 - 1-13/16" (46mm) x 2-3/4" (70mm)
2000 - 11/16" (18 mm) x 3-1/8" (79mm)
 Corresponding Baseboard #2051D, #2051C
 2001 - SPECIES: W/W
 2000 - SPECIES: W/W

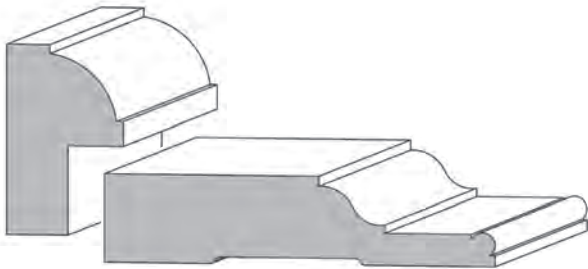

2011 - 1-5/16" (33mm) x 2-1/8" (54mm)
2010 - 1" (25 mm) x 4-1/2" (114mm)
 Corresponding Baseboard #2053D
 2011 SPECIES: W/W
 2010 SPECIES: W/W

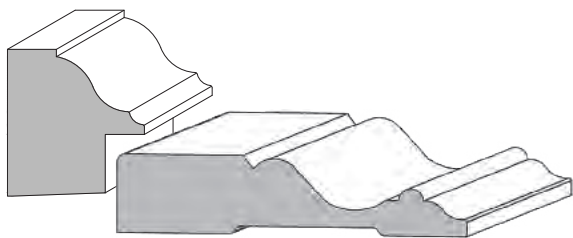

33A - 1-5/8" (41mm) x 1-11/16" (47mm) 3/4" (20mm) Rabbet
1A - 3/4" (20mm) x 3-1/2" (89mm)
 Corresponding Baseboard #42B or #42C
 33A- SPECIES: W/W
 1A- SPECIES: W/W OAK WALNUT

BASEBOARDS

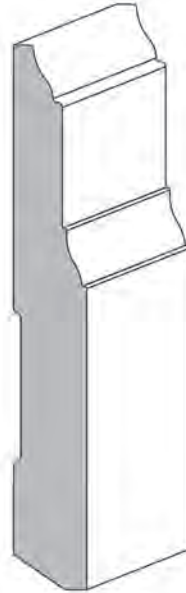

25C - 3/4" (19 mm) x 7-1/4" (184mm)
25B - 3/4" (19 mm) x 5-1/2" (140mm)
 Corresponding Casing #25S or #25A
 25C - SPECIES: W/W MAPLE WALNUT
 25B - SPECIES: W/W

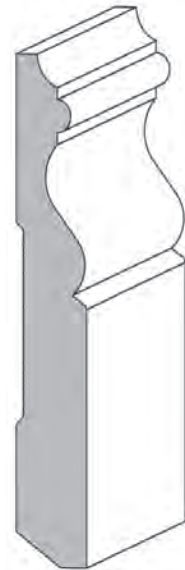

42C - 3/4" (19 mm) x 7-1/4" (184mm)
42A - 3/4" (19 mm) x 6-1/2" (165mm)
42B - 3/4" (19 mm) x 5-1/2" (140mm)
42 - 3/4" (19 mm) x 4-1/2" (114mm)
 Corresponding Casing #1 or #1A

42C - SPECIES: W/W WALNUT
 42A - SPECIES: W/W
 42B - SPECIES: W/W OAK PINE MAPLE
 42 - SPECIES: W/W OAK PINE MAPLE

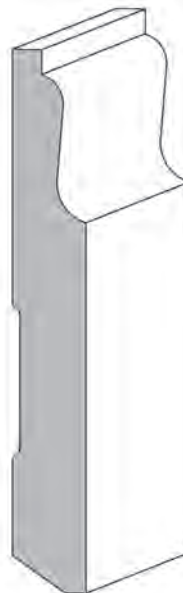

53 - 3/4" (19 mm) x 5-1/2" (140mm)
 Corresponding Casing #4, #22 or #23
 SPECIES: W/W

BASEBOARDS



302C - 3/4" (19 mm) x 7-1/4" (184mm)
Corresponding Casing #102
SPECIES: W/W

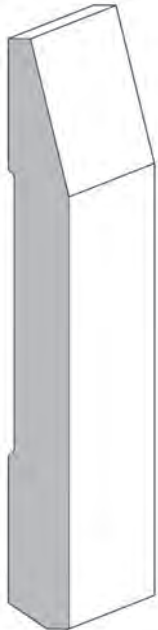

306 - 3/4" (19 mm) x 7-1/4" (184mm)
Corresponding Casing #101 &
Corresponding Backband #38
SPECIES: W/W PINE

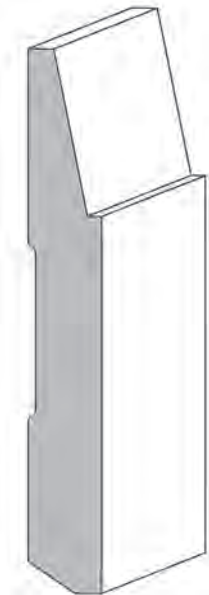

307C - 3/4" (19 mm) x 7-1/4" (184mm)
307 - 3/4" (19 mm) x 5-1/2" (140mm)
307E - 3/4" (19mm) x 9-1/4" (235mm)
Corresponding Casing #106 or #106A

307C - SPECIES: W/W OAK MAPLE
EZ BEND MAHOGANY WALNUT
307 - SPECIES: W/W MAPLE
307E - SPECIES: W/W

BASEBOARDS

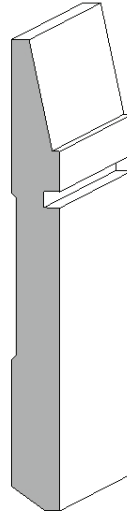

307GR - 3/4" (20mm) x 7-1/4" (184mm)
Corresponding Casing #106GR
SPECIES: W/W



308 - 3/4" (19 mm) x 8-1/2" (216mm)
Corresponding Casing #102 and
Corresponding Backband #33
SPECIES: W/W



309 - 3/4" (19 mm) x 8-1/2" (216mm)
Corresponding Casing #2005
Corresponding Backband #2006
SPECIES: W/W

BASEBOARDS

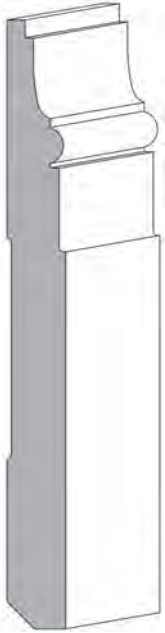

310 - 13/16" (21mm) x 8-1/2" (216mm)
Corresponding Casing #2015 & Backband #2016
SPECIES: W/W

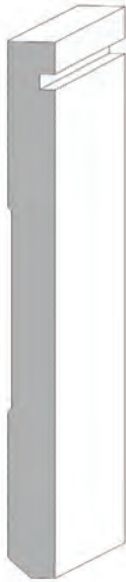

311 - 3/4" (20 mm) x 7-1/4" (184mm)
Corresponding Casing #11
SPECIES: W/W, EZ BEND



NEW
311A - 3/4" (20mm) x 5-1/2" (140mm)
Corresponding Casing #11
SPECIES: W/W

BASEBOARDS

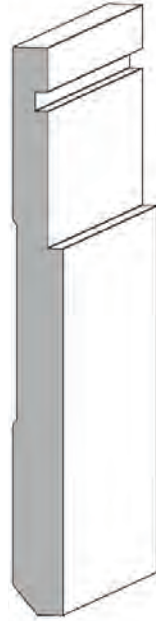

313 - 3/4" (19mm) x 7-1/4" (184mm)
Corresponding Casing #413
SPECIES: W/W

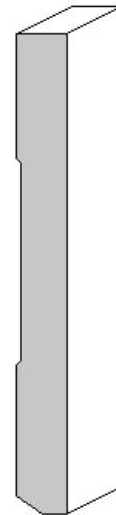

314 - 3/4" (19mm) x 5-1/2" (140mm)
Corresponding Casing #414 & Backband #40
SPECIES: W/W

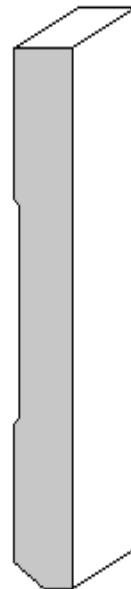

315 - 3/4" (19 mm) x 7-1/4" (184mm)
Corresponding Casing #415 Backband #40
SPECIES: W/W

BASEBOARDS



NEW

316 - 5/8" (16mm) x 5" (127mm)
Corresponding Casing #416
SPECIES: W/W

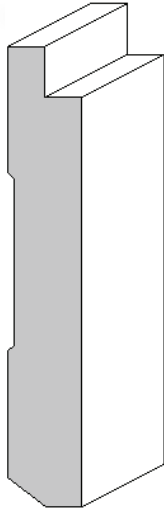

320 - 3/4" (19mm) x 4-1/2" (114mm)
Corresponding Casing #420
SPECIES: W/W



NEW

320C - 3/4" (19mm) x 7-1/4" (184mm)
Corresponding Casing #420
SPECIES: W/W

BASEBOARDS

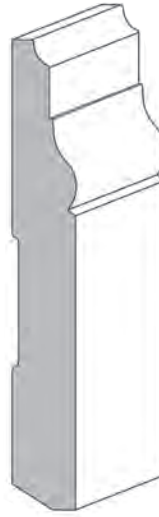

349B - 3/4" (19 mm) x 7-1/4" (184mm)
349 - 3/4" (19 mm) x 5-1/2" (140mm)
349A - 3/4" (19 mm) x 4-7/8" (124mm)
Corresponding Casing #7A or #7
349A - SPECIES: W/W
349B - SPECIES: W/W EZ BEND WALNUT
349 - SPECIES: W/W

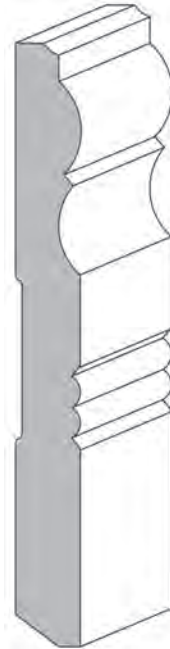

353B - 3/4" (19 mm) x 7-1/4" (184mm)
Corresponding Casing #19
SPECIES: W/W

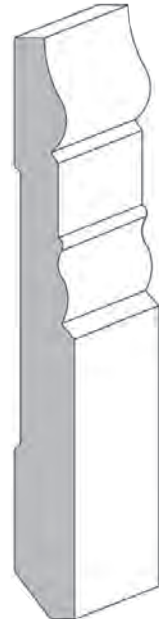

354 - 3/4" (19 mm) x 7-1/4" (184mm)
Corresponding Casing #20
Corresponding Backband #30
SPECIES: W/W

BASEBOARDS

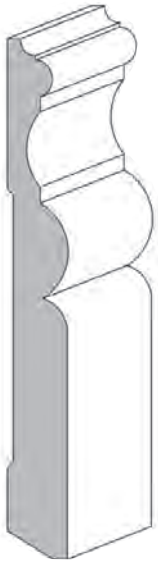

352B - 3/4" (19 mm) x 7-1/4" (184mm)
352 - 3/4" (19 mm) x 6-1/2" (165mm)
Corresponding Casing #1A or #800
352 - SPECIES: W/W
352B - SPECIES: W/W OAK EZ BEND

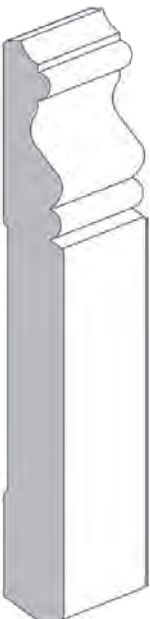
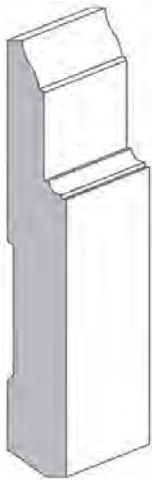

820 - 3/4" (19mm) x 7-1/4" (184mm)
Corresponding Casing #810
SPECIES: W/W

358 - 3/4" (19 mm) x 5-1/2" (140mm)
Corresponding Casing #23 and Backband #30
SPECIES: W/W

BASEBOARDS

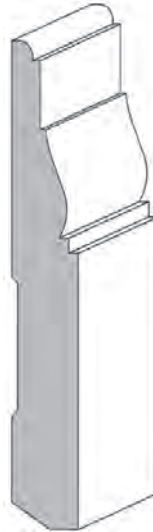

900D - 7/8" (22 mm) x 8-1/2" (216mm)
900C - 7/8" (22 mm) x 7-1/4" (184mm)
900 - 7/8" (22 mm) x 5-1/2" (140mm)
Corresponding Casing #700 or #700B
900D/900C - SPECIES: W/W EZ BEND
900 - SPECIES: W/W

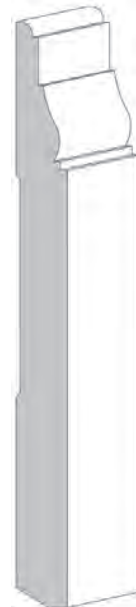

910 - 13/16" (21mm) x 9-1/4" (235mm)
Corresponding Casing #700 or #700B
SPECIES: W/W

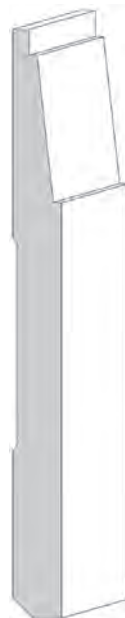

2140 - 3/4" (19mm) x 8-1/2" (216mm)
Corresponding Casing #2100
SPECIES: W/W OAK

BASEBOARDS



2148 - 13/16" (21mm) x 9-1/4" (235mm)
Corresponding Casing #2108
SPECIES: W/W

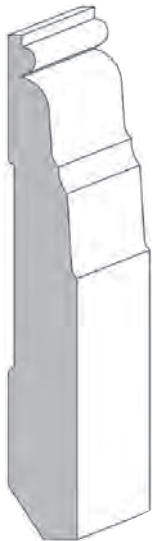

2053D - 1" (25mm) x 8-1/2" (216mm)
Corresponding Casing #2010 or #2015
SPECIES: W/W

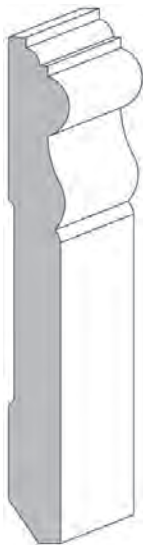

2051D - 7/8" (22 mm) x 8-1/2" (216mm)
2051C - 7/8" (22 mm) x 7-1/4" (184mm)
Corresponding Casing #2000, #2005
2051D - SPECIES: W/W EZ BEND
2051C - SPECIES: W/W

PLINTH BLOCKS

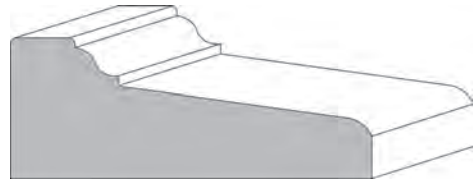

338 - 1-3/4" (44mm) x 4-3/8" (111mm)
Accommodates 3-1/2" Casing & Backband #34
SPECIES: W/W



735 - 1-15/16" (49mm) x 4-7/16" (113mm)
Accommodates 3-1/2" Casing & Backband #35
SPECIES: W/W

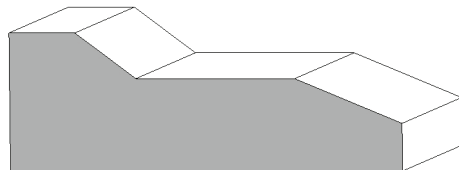

736 - 1-9/16" (40mm) x 4-13/32" (111mm)
SPECIES: W/W

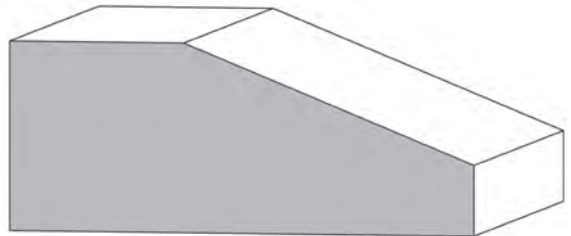

2002 - 2-1/4" (57mm) x 5-1/2" (140mm)
Accommodates Casing #2000 & Backband #2001
SPECIES: W/W

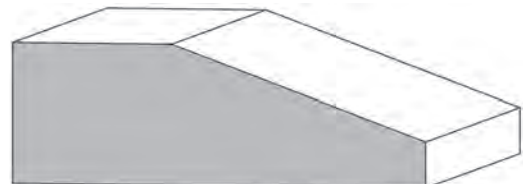

2007 - 1-11/16" (43mm) x 4-5/8" (117mm)
Accommodates Casing #2005 & Backband #2006
SPECIES: W/W

PLINTH BLOCKS

TWO-PIECE PLINTH BLOCKS

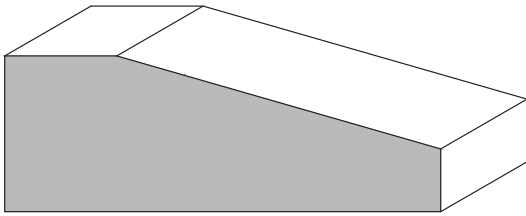

2013 - 1-9/16" (43mm) x 4-3/8" (117mm)

Accommodations:

Option 1: Casing #101 & Backband #38

Option 2: Casing #102 & Backband #34

Option 3: Casing #106 & Backband #37

SPECIES: W/W

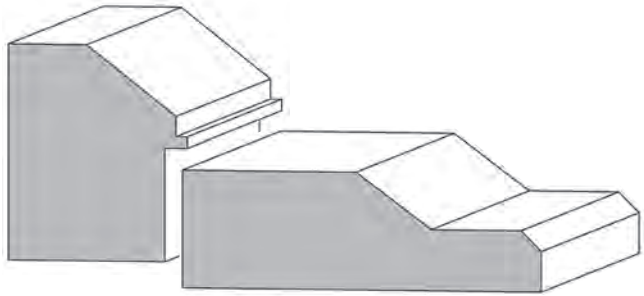

2012 - 2-3/8" (60mm) x 5-5/8" (143mm)

Accommodates Casing #2010 & Backband #2011

SPECIES: W/W

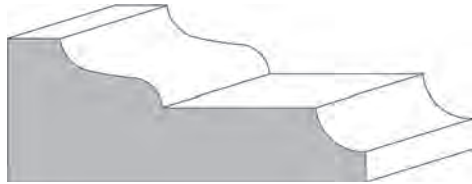

2030 - 1-3/4" (44mm) x 4-3/8" (111mm)

Accommodates 2-3/4" Casing & Backband #30

SPECIES: W/W

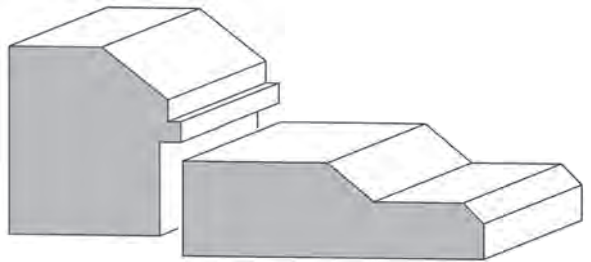

2017 - 2" (51mm) x 4-7/8" (124mm)

Accommodates Casing #2015 & Backband #2016

SPECIES: W/W

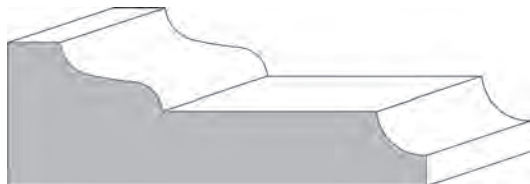

2030B - 1-3/4" (44mm) x 5-1/8" (130mm)

Accommodates 3-1/2" Casing & Backband #30

SPECIES: W/W

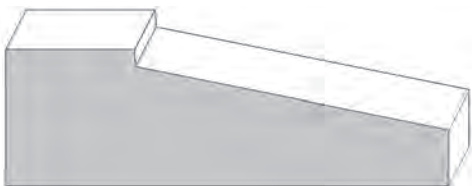

2130 - 1-1/2" (38mm) x 4-7/8" (124mm)

Accommodates Casing #2100

SPECIES: W/W

*Plinth Block runs in lineal foot lengths and are designed to be cut to length at job site.

DOOR STOPS / BASE SHOES

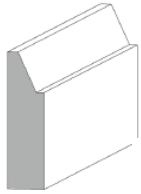

108 - 7/16" (11mm) x 1-5/8" (41mm)
SPECIES: W/W OAK PINE MAPLE MAHOGANY
WALNUT EZ BEND

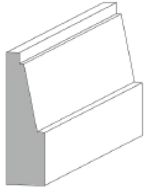

109 - 7/16" (11mm) x 1-1/2" (38mm)
SPECIES: W/W

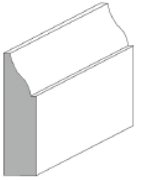

110 - 3/8" (10mm) x 1-3/8" (35mm)
SPECIES: W/W OAK PINE MAPLE
MAHOGANY WALNUT EZBEND

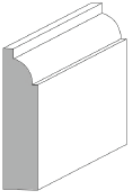

111 - 7/16" (11mm) x 1-3/4" (44mm)
SPECIES: W/W

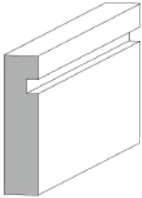

112 - 3/8" (10mm) x 1-1/2" (38mm)
SPECIES: W/W EZ BEND

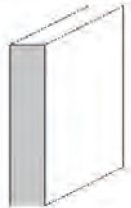

112A - 3/8" (10mm) x 1-3/4" (44mm)
SPECIES: W/W EZ BEND

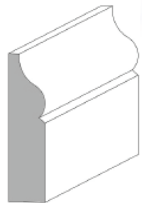

113 - 7/16" (11mm) x 1-3/4" (44mm)
SPECIES: W/W OAK MAPLE MAHOGANY
WALNUT EZ BEND

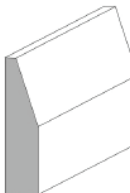

114 - 3/8" (10mm) x 1-1/2" (38mm)
SPECIES: W/W

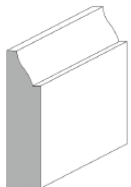

116 - 7/16" (11mm) x 1-3/4" (44mm)
SPECIES: W/W OAK EZ BEND

DOOR STOPS / BASE SHOES

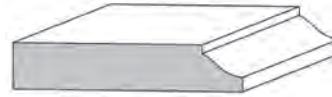

117 - 1/2" (13mm) x 2-1/2" (64mm)
SPECIES: W/W PINE

BASE SHOES

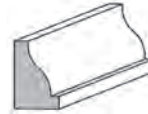

208 - 1/2" (13mm) x 3/4" (19mm)
SPECIES: W/W OAK PINE MAPLE WALNUT
EZ BEND

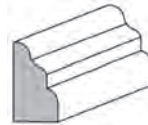

209 - 1/2" (13mm) x 7/8" (22mm)
SPECIES: W/W

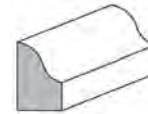

210 - 1/2" (13mm) x 3/4" (19mm)
SPECIES: W/W

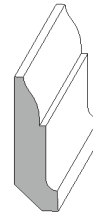

216 - 1/2" (13mm) x 1-5/8" (41mm)
SPECIES: W/W



MODERN 1
CASING: 106
BASEBOARD: 307C



MODERN 3
CASING: 106
BASEBOARD: 314



MODERN 2
CASING: 106A
BASEBOARD: 307



MODERN 4
CASING: 101
BASEBOARD: 306



MODERN 5
CASING: 11
BASEBOARD: 311



MODERN 7
CASING: 413
BASEBOARD: 313



MODERN 6
CASING: 11
BASEBOARD: 311



MODERN 8
CASING: 106GR
BASEBOARD: 307GR



MODERN 9
CASING: 415
BASEBOARD: 315



MODERN 11
CASING: 414
BASEBOARD: 314



MODERN 10
CASING: 415
BACKBAND: 40
BASEBOARD: 315



MODERN 12
CASING: 420
BASEBOARD: 320



TRANSITIONAL 1
CASING: 106
BACKBAND: 37
BASEBOARD: 307C
BASE SHOE: 108



TRANSITIONAL 3
CASING: 106
BACKBAND: 704
BASEBOARD: 307C
BASE SHOE: 335
PLINTH: 736

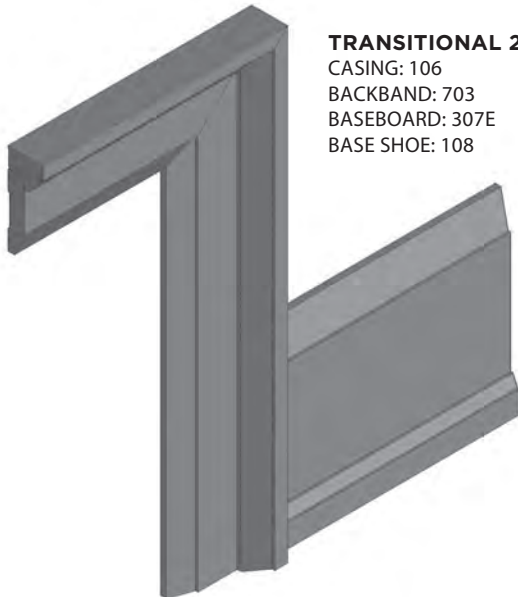

TRANSITIONAL 2
CASING: 106
BACKBAND: 703
BASEBOARD: 307E
BASE SHOE: 108



TRANSITIONAL 4
CASING: 2100
BASEBOARD: 2140
BASE SHOE: 109



TRANSITIONAL 5
CASING: 101
BACKBAND: 38
BASEBOARD: 306
BASE SHOE: 114

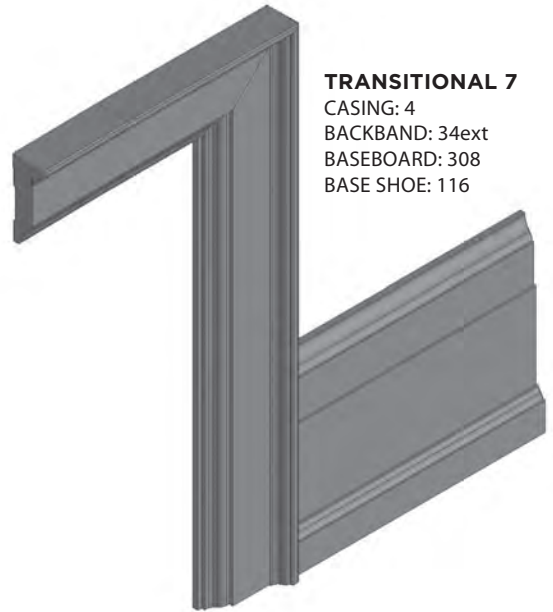

TRANSITIONAL 7
CASING: 4
BACKBAND: 34ext
BASEBOARD: 308
BASE SHOE: 116



TRANSITIONAL 6
CASING: 102
BACKBAND: 34
BASEBOARD: 302C
BASE SHOE: 116



TRANSITIONAL 8
CASING: 20B
BACKBAND: 39
BASEBOARD: 314
BASE SHOE: 157



TRANSITIONAL 9

CASING: 25A
BACKBAND: 34
BASEBOARD: 25C
BASE SHOE: 116

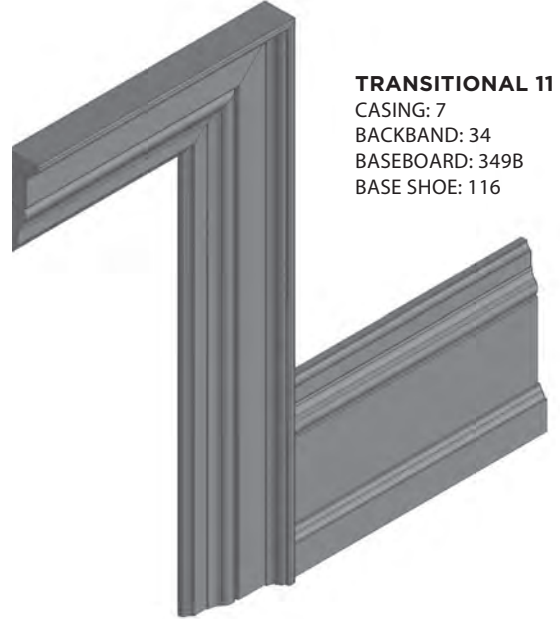

TRANSITIONAL 11

CASING: 7
BACKBAND: 34
BASEBOARD: 349B
BASE SHOE: 116



TRANSITIONAL 10

CASING: 23
BACKBAND: 39
BASEBOARD: 358
BASE SHOE: 110

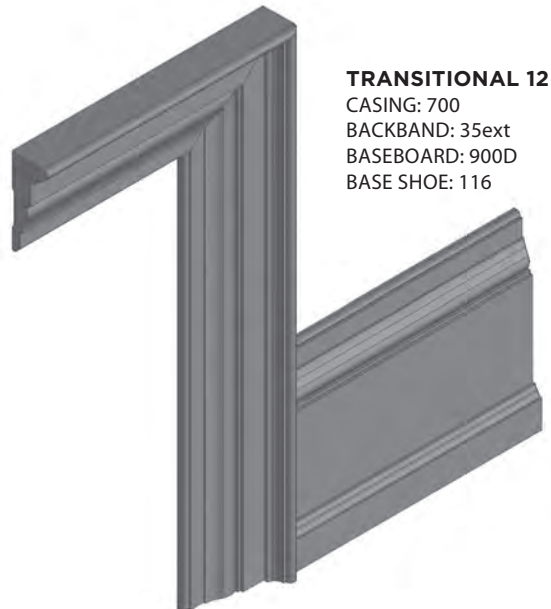

TRANSITIONAL 12

CASING: 700
BACKBAND: 35ext
BASEBOARD: 900D
BASE SHOE: 116

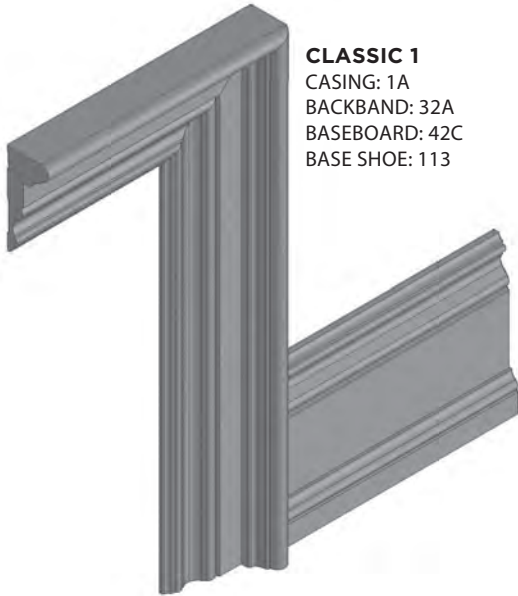

CLASSIC 1
CASING: 1A
BACKBAND: 32A
BASEBOARD: 42C
BASE SHOE: 113



CLASSIC 3
CASING: 800
BACKBAND: 35ext
BASEBOARD: 352B
BASE SHOE: 113
PLINTH: 735

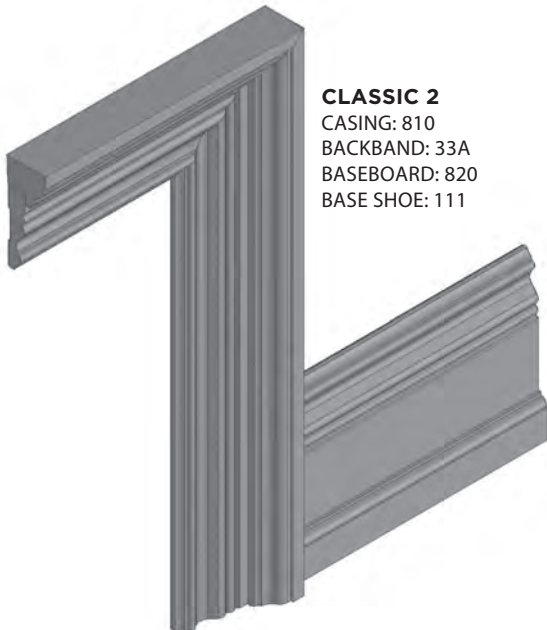

CLASSIC 2
CASING: 810
BACKBAND: 33A
BASEBOARD: 820
BASE SHOE: 111

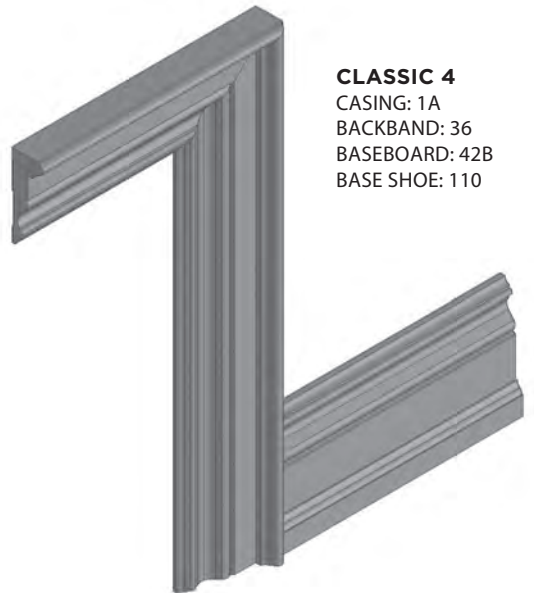

CLASSIC 4
CASING: 1A
BACKBAND: 36
BASEBOARD: 42B
BASE SHOE: 110



CLASSIC 5
CASING: 20B
BACKBAND: 30
BASEBOARD: 910
BASE SHOE: 158
PLINTH: 2030B



CLASSIC 7
CASING: 102
BACKBAND: 33
BASEBOARD: 2051C
BASE SHOE: 116

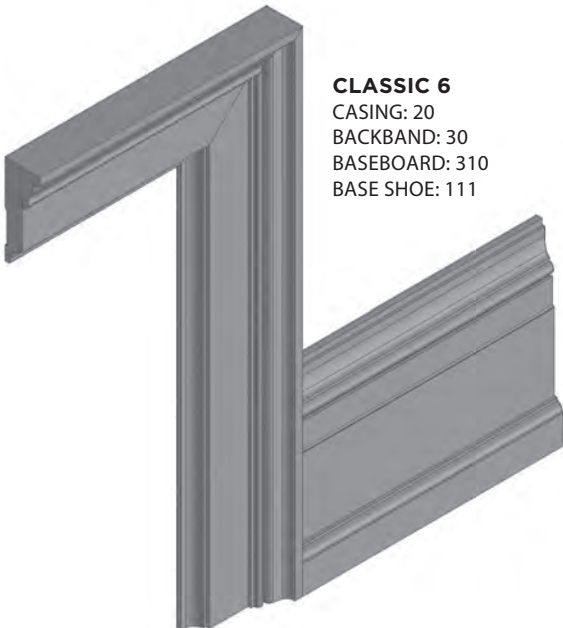

CLASSIC 6
CASING: 20
BACKBAND: 30
BASEBOARD: 310
BASE SHOE: 111



CLASSIC 8
CASING: 22
BACKBAND: 30
BASEBOARD: 354
BASE SHOE: 116

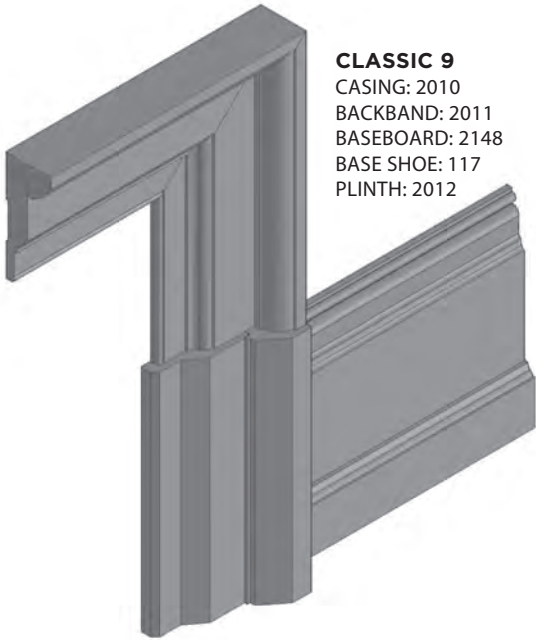

CLASSIC 9
CASING: 2010
BACKBAND: 2011
BASEBOARD: 2148
BASE SHOE: 117
PLINTH: 2012

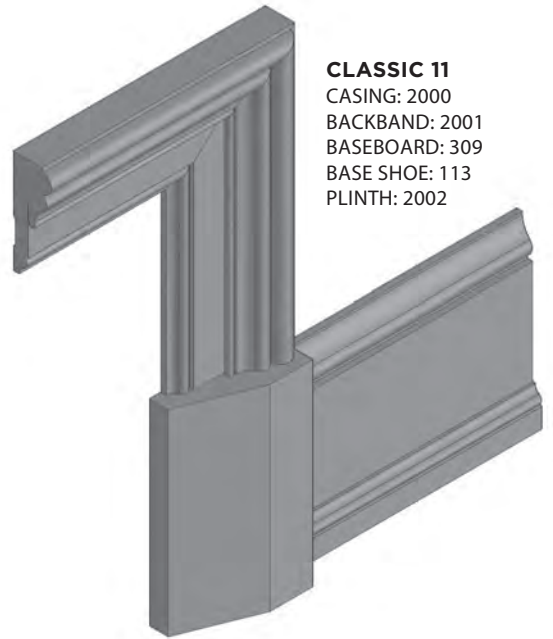

CLASSIC 11
CASING: 2000
BACKBAND: 2001
BASEBOARD: 309
BASE SHOE: 113
PLINTH: 2002

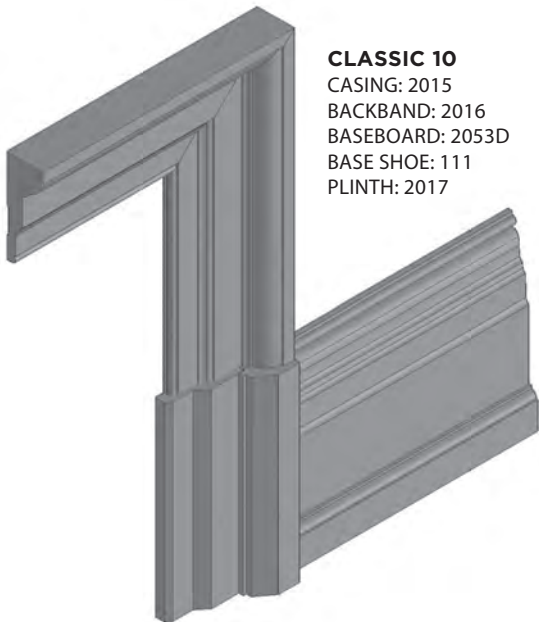

CLASSIC 10
CASING: 2015
BACKBAND: 2016
BASEBOARD: 2053D
BASE SHOE: 111
PLINTH: 2017



CLASSIC 12
CASING: 2000
BACKBAND: 2006
BASEBOARD: 2051C
BASE SHOE: 111
PLINTH: 2007

WINDOW STOOL

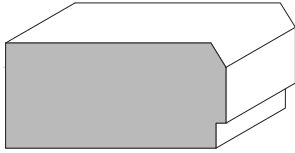

226 - 1-5/16" (33mm) x 2-3/4" (70mm)
SPECIES: W/W

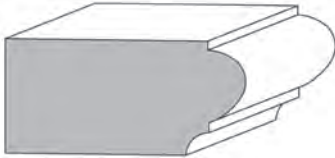

227 - 1-5/16" (33mm) x 2-3/4" (70mm)
SPECIES: W/W OAK MAPLE MAHOGANY WALNUT



232 - 1-1/16" x 7-3/4" SPECIES: W/W

231 - 1-1/16" x 5-1/4" SPECIES: W/W

230 - 1-1/16" x 4-1/4" SPECIES: W/W PINE

229 - 1-1/16" x 3-1/4" SPECIES: W/W PINE

228 - 1-1/16" x 2-1/4" SPECIES: W/W OAK PINE

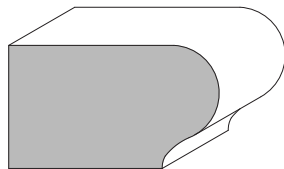

233 - 1-5/8" (41mm) x 2-3/4" (70mm)
SPECIES: W/W

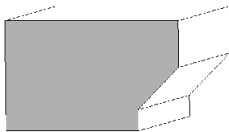

234 - 1-5/8" (41mm) x 2-3/8" (60mm)
SPECIES: W/W OAK MAPLE MAHOGANY WALNUT

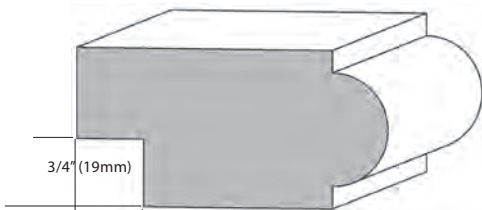

MK - 1-3/4" (44mm) x 3-1/2" (89mm)
SPECIES: W/W

BOLECTIONS & APRONS

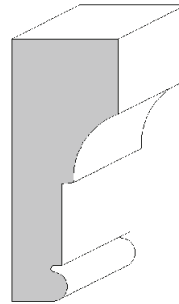

81 - 1-5/16" (33mm) x 3-1/4" (83mm)
SPECIES: W/W

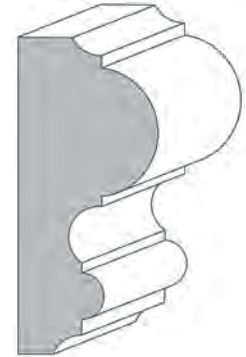

82 - 1-3/4" (44mm) x 4" (102mm)
SPECIES: W/W



83 - 1-5/8" (41mm) x 5-1/2" (140mm)
SPECIES: W/W

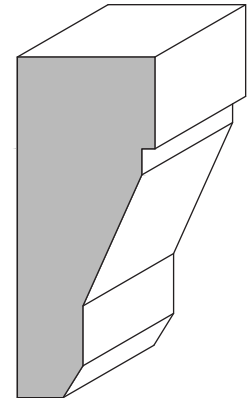

85 - 1-5/16" (33mm) x 3-1/4" (83mm)
SPECIES: W/W OAK

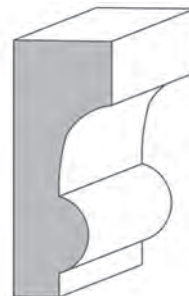

88 - 1-1/4" (32mm) x 3-1/4" (83mm)
SPECIES: W/W

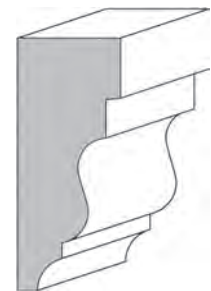

89 - 1-5/16" (33mm) x 3-1/4" (83mm)
SPECIES: W/W

BOLECTIONS & APRONS

WINDOW STOOL & APRON COMBINATIONS

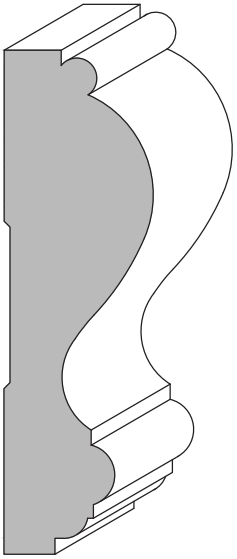

663 - 1-5/8" (41mm) x 5-1/2" (140mm)
SPECIES: W/W

STOOL
226

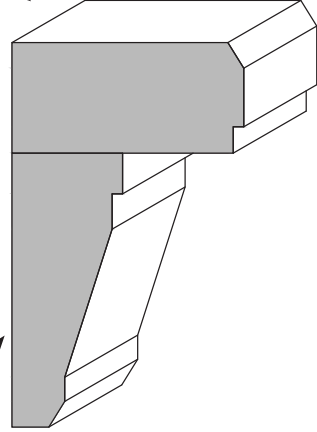

APRON 85

STOOL 229

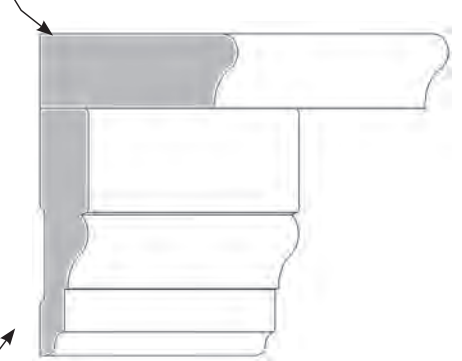

CASING 7

STOOL MK

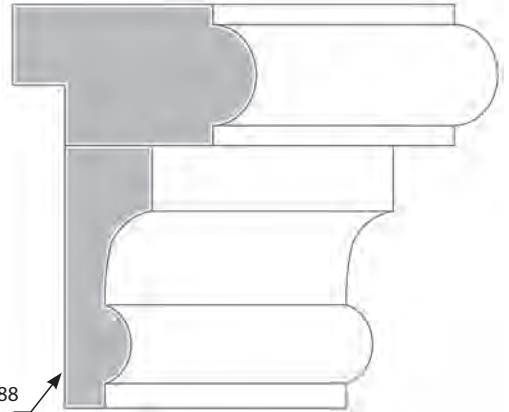

APRON 88

CROWN MOULDS

CROWN MOULDS

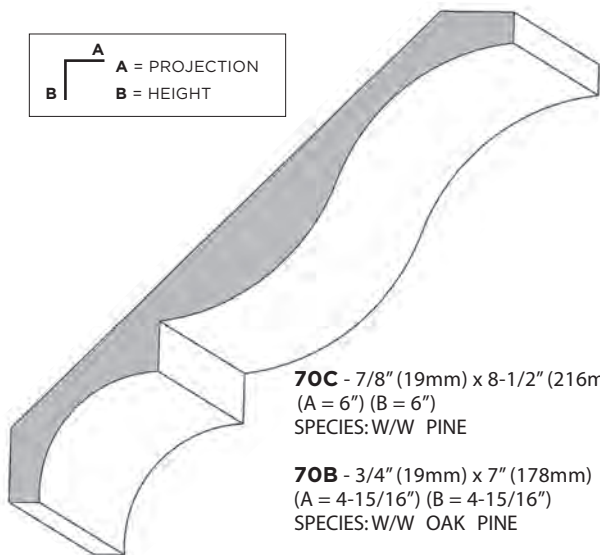
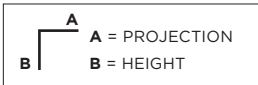

70C - 7/8" (19mm) x 8-1/2" (216mm)
(A = 6") (B = 6")
SPECIES: W/W PINE

70B - 3/4" (19mm) x 7" (178mm)
(A = 4-15/16") (B = 4-15/16")
SPECIES: W/W OAK PINE

70 - 3/4" (19mm) x 5-1/4" (133mm)
(A = 3-9/16") (B = 3-9/16")
SPECIES: W/W OAK PINE MAPLE
MAHOGANY WALNUT



71 - 3/4" (44mm) x 4-1/4" (108mm)
(A = 2-15/16") (B = 2-15/16")
SPECIES: W/W OAK PINE MAPLE
WALNUT

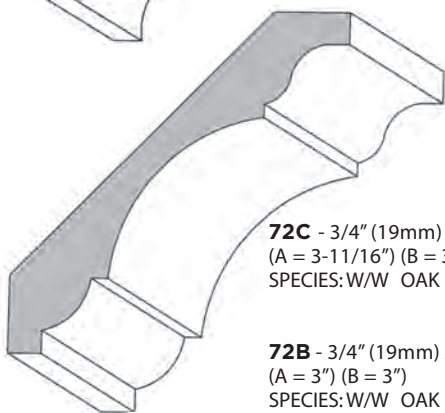

72C - 3/4" (19mm) x 5-1/4" (133mm)
(A = 3-11/16") (B = 3-11/16")
SPECIES: W/W OAK PINE MAPLE

72B - 3/4" (19mm) x 4-1/4" (108mm)
(A = 3") (B = 3")
SPECIES: W/W OAK PINE MAPLE
MAHOGANY WALNUT

72 - 3/4" (19mm) x 3-1/2" (89mm)
(A = 2-1/2") (B = 2-1/2")
SPECIES: W/W PINE MAPLE WALNUT

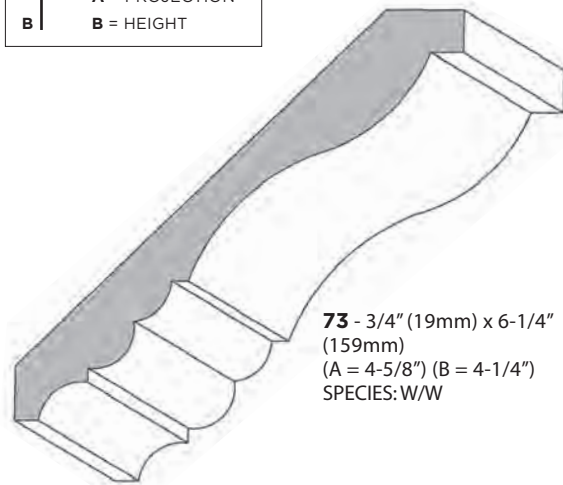
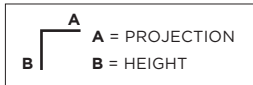

73 - 3/4" (19mm) x 6-1/4"
(159mm)
(A = 4-5/8") (B = 4-1/4")
SPECIES: W/W

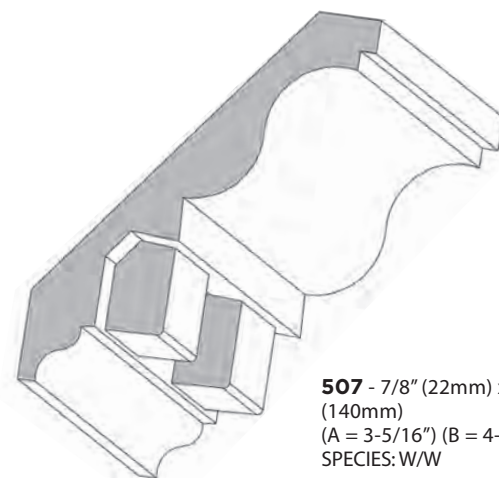

507 - 7/8" (22mm) x 5-1/2"
(140mm)
(A = 3-5/16") (B = 4-3/8")
SPECIES: W/W

NON-STOCK

509 - 7/8" (22mm) x 3-11/16"
(94mm)
(A = 2-9/16") (B = 2-11/16")
SPECIES: W/W

NON-STOCK

CROWN MOULDS

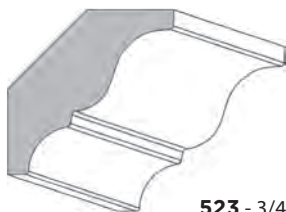
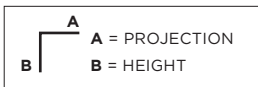

523 - 3/4" (19mm) x 2-3/8" (60mm)
(A = 1-11/16") (B = 1-21/32")
SPECIES: W/W MAPLE

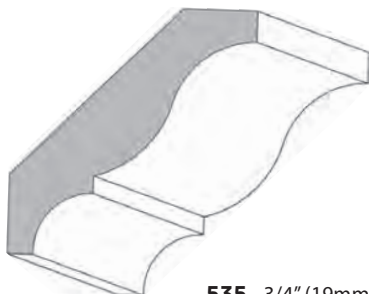

535 - 3/4" (19mm) x 3-1/2" (89mm)
(A = 2-7/16") (B = 2-1/2")
SPECIES: W/W MAPLE

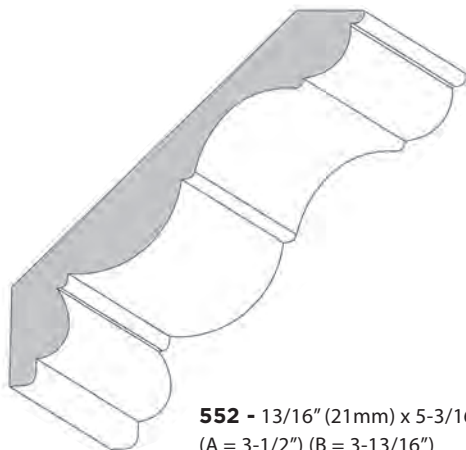

552 - 13/16" (21mm) x 5-3/16" (132mm)
(A = 3-1/2") (B = 3-13/16")
SPECIES: W/W

CROWN MOULDS

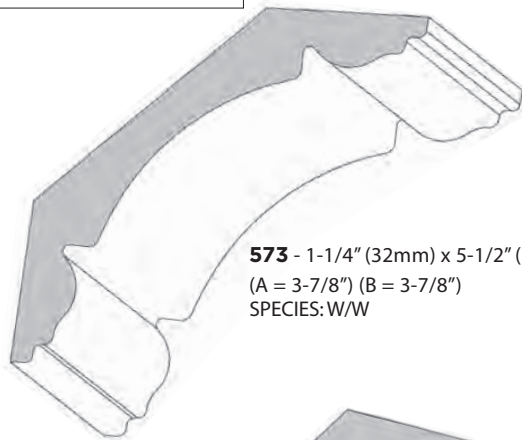
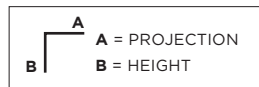

573 - 1-1/4" (32mm) x 5-1/2" (140mm)
(A = 3-7/8") (B = 3-7/8")
SPECIES: W/W

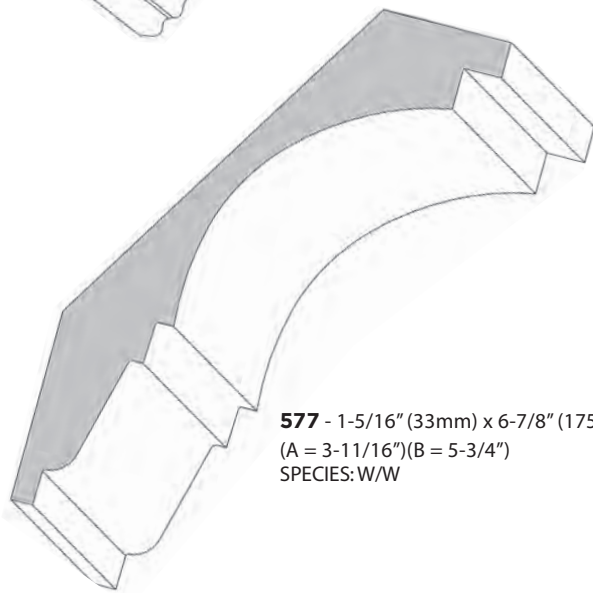

577 - 1-5/16" (33mm) x 6-7/8" (175mm)
(A = 3-11/16") (B = 5-3/4")
SPECIES: W/W



578 - 1" (25mm) x 4-3/4" (121mm)
(A = 3-1/4") (B = 3-3/8")
SPECIES: W/W

CROWN MOULDS

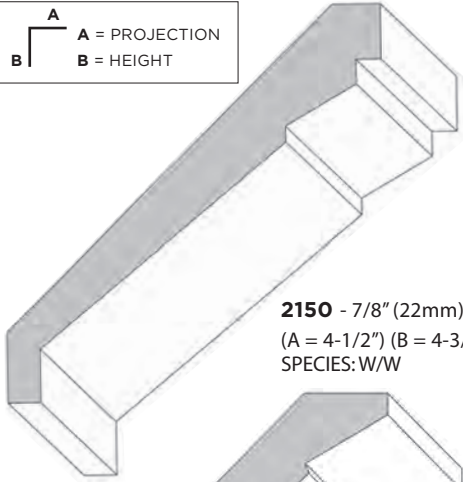
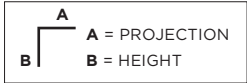

2150 - 7/8" (22mm) x 6-1/2" (165mm)
(A = 4-1/2") (B = 4-3/4")
SPECIES: W/W

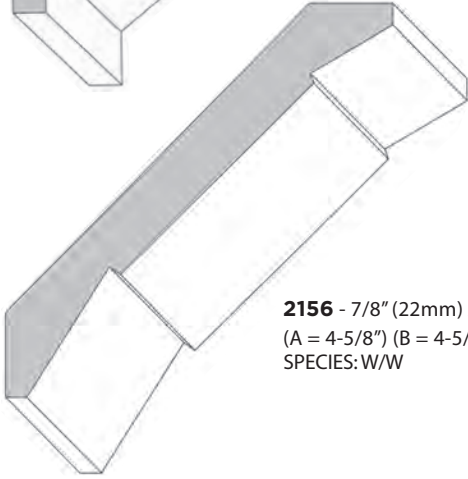

2156 - 7/8" (22mm) x 6-1/2" (165mm)
(A = 4-5/8") (B = 4-5/8")
SPECIES: W/W

COVE MOULDS

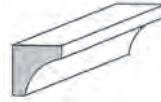

90 - 1/2" (13mm) x 1/2" (13mm)
SPECIES: W/W OAK PINE MAPLE

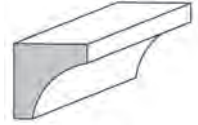

91 - 3/4" (19mm) x 3/4" (19mm)
SPECIES: W/W OAK PINE
MAPLE EZ BEND

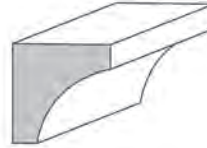

92 - 1" (25mm) x 1" (25mm)
SPECIES: W/W PINE

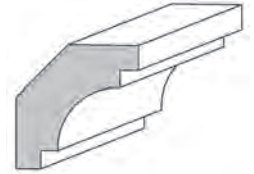

93 - 3/4" (19mm) x 1-3/4" (44mm)
SPECIES: W/W PINE MAPLE

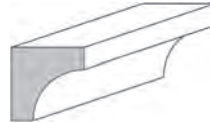

95 - 5/8" (16mm) x 5/8" (16mm)
SPECIES: W/W

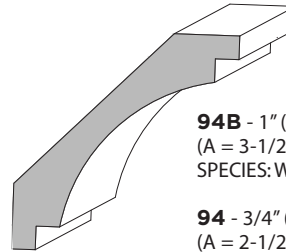

94B - 1" (25mm) x 4-15/16" (126mm)
(A = 3-1/2") (B = 3-1/2")
SPECIES: W/W

94 - 3/4" (19mm) x 3-1/2" (89mm)
(A = 2-1/2") (B = 2-1/2")
SPECIES: W/W OAK PINE MAPLE

CAP MOULDS

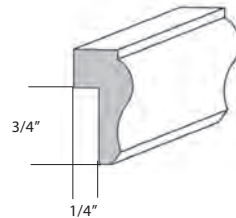

97 - 9/16" (14mm) x 1-1/8" (29mm)
SPECIES: W/W

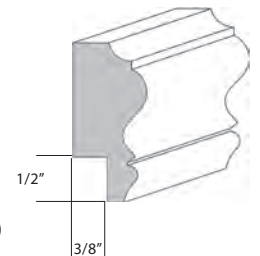

98 - 13/16" (21mm) x 1-3/4" (44mm)
SPECIES: W/W

CEILING & BEAM COMBINATIONS

PANEL MOULDS - INSET

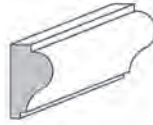
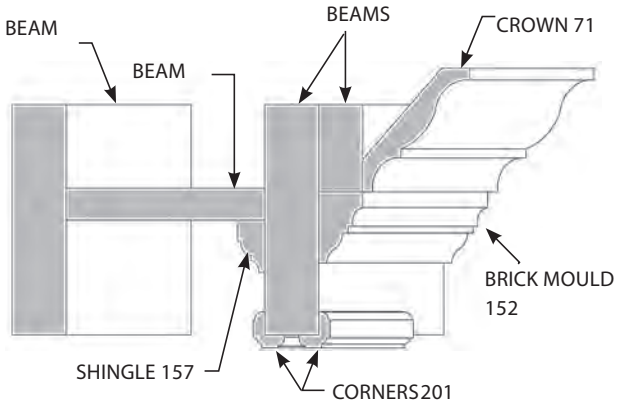

118 - 7/16" (11mm) x 3/4" (19mm)
SPECIES: W/W OAK PINE MAPLE MAHOGANY
WALNUT EZ BEND

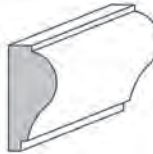

119 - 1/2" (13mm) x 1-1/16" (27mm)
SPECIES: W/W OAK PINE MAPLE MAHOGANY
WALNUT EZ BEND

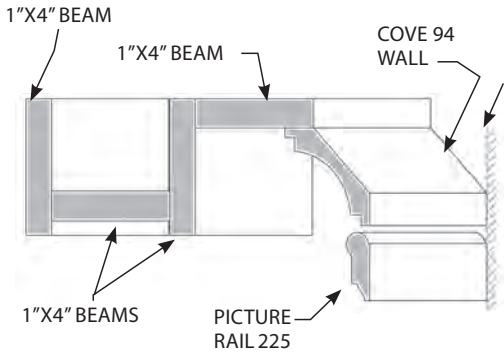

122 - 5/8" (16mm) x 1-9/16" (40mm)
SPECIES: W/W

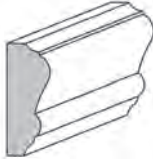

122A - 7/16" (11mm) x 1-1/8" (29mm)
SPECIES: W/W OAK PINE MAPLE EZ BEND

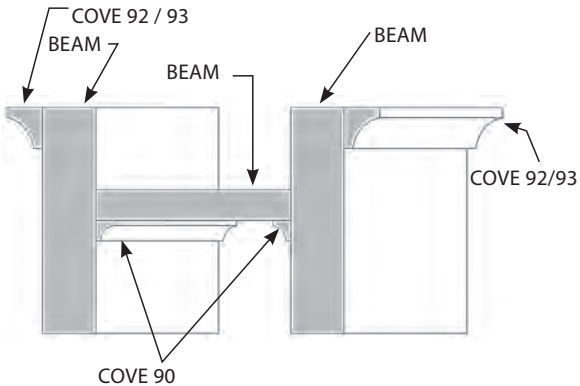

122B - 3/4" (19mm) x 2-3/16" (56mm)
SPECIES: W/W

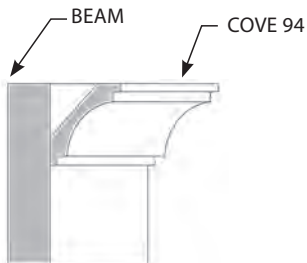

124 - 3/4" (19mm) x 2-1/4" (57mm)
SPECIES: W/W

PANEL MOULDS - INSET

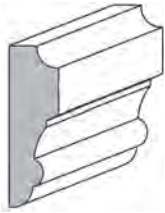

126 - 1/2" (13mm) x 1-5/8" (41mm)
SPECIES: W/W

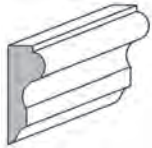

129 - 3/8" (10mm) x 1" (25mm)
SPECIES: W/W MAPLE

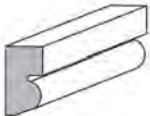

134 - 3/8" (10mm) x 11/16" (17mm)
SPECIES: W/W MAPLE

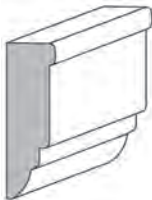

327 - 1/2" (13mm) x 1-3/4" (44mm)
SPECIES: W/W

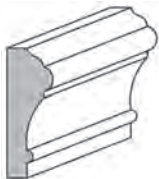

328 - 7/16" (11mm) x 1-5/16" (33mm)
SPECIES: W/W MAPLE WALNUT

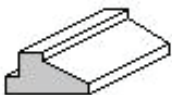

607 - 7/16" (11mm) x 7/8" (22mm)
SPECIES: W/W

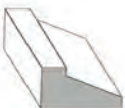

608 - 7/16" (11mm) x 11/16" (17mm)
SPECIES: W/W MAHOGANY

PANEL MOULDS - INSET



609 - 7/16" (11mm) x 1-1/4" (32mm)
SPECIES: W/W



NEW

610TL - 7/16" (11mm) x 3/8" (10mm)
SPECIES: W/W



NEW

611TL - 7/16" (11mm) x 3/8" (10mm)
SPECIES: W/W



NEW

612TL - 7/16" (11mm) x 3/8" (10mm)
SPECIES: W/W

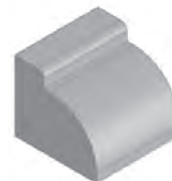

NEW

613TL - 7/16" (11mm) x 3/8" (10mm)
SPECIES: W/W



620 - 1/2" (13mm) x 1-1/4" (32mm)
SPECIES: W/W

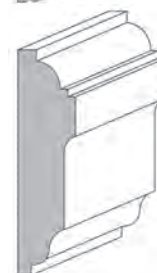

645 - 11/16" (17mm) x 2-1/2" (64mm)
SPECIES: W/W

PANEL MOULDS - INSET

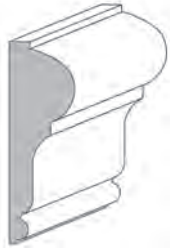

648 - 3/4" (19mm) x 2-1/4" (57mm)
SPECIES: W/W

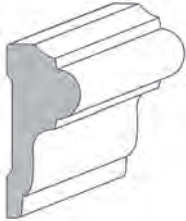

649 - 3/4" (19mm) x 1-3/4" (44mm)
SPECIES: W/W



666 - 1/2" (13mm) x 7/8" (22mm)
SPECIES: W/W OAK

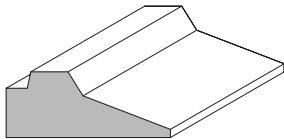

333 - 1/2" (13mm) x 1-1/4" (32mm)
SPECIES: W/W

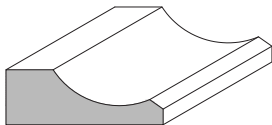

334 - 7/16" (11mm) x 1-1/4" (32mm)
SPECIES: W/W

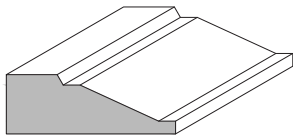

335 - 7/16" (11mm) x 1-1/4" (32mm)
SPECIES: W/W

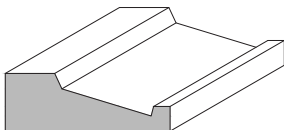

336 - 7/16" (11mm) x 1-1/4" (32mm)
SPECIES: W/W

PANEL MOULDS - RAISED

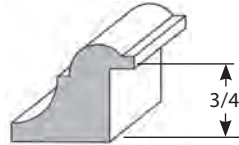

130 - 1" (25mm) x 1-1/4" (32mm)
SPECIES: W/W OAK PINE

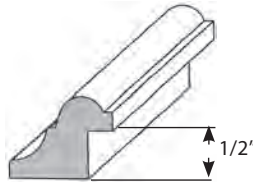

130S - 7/8" (22mm) x 1" (25mm)
SPECIES: W/W OAK MAPLE
EZ BEND

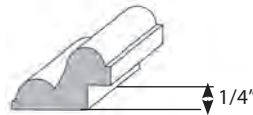

131 - 5/8" (16mm) x 1" (25mm)
SPECIES: W/W OAK PINE MAPLE
MAHOGANY WALNUT

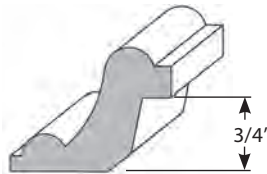

132 - 1-1/4" (32mm) x 1-5/8" (41mm)
SPECIES: W/W OAK PINE MAPLE
MAHOGANY WALNUT

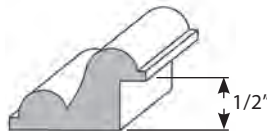

133 - 13/16" (21mm) x 1-3/8" (35mm)
SPECIES: W/W OAK PINE MAPLE
MAHOGANY WALNUT
EZ BEND

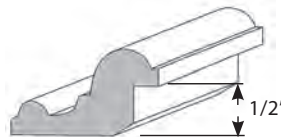

632 - 7/8" (22mm) x 1-1/2" (38mm)
SPECIES: W/W OAK MAPLE



651 - 7/8" (22mm) x 3" (76mm)
SPECIES: W/W



652 - 7/8" (22mm) x 3" (76mm)
SPECIES: W/W

PANEL MOULDS - RAISED

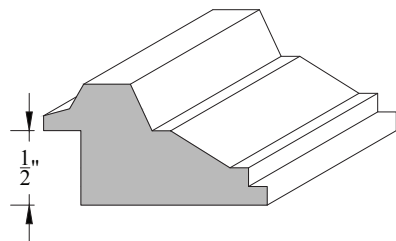

670 - 13/16" (21mm) x 1-1/2" (38mm)
SPECIES: W/W

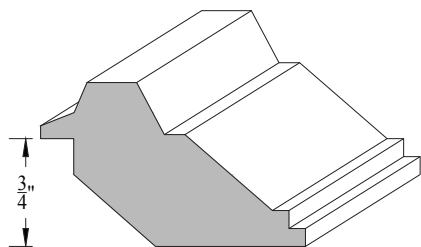

671 - 1-1/8" (29mm) x 2" (51mm)
SPECIES: W/W

BED MOULDS & QUARTER ROUNDS

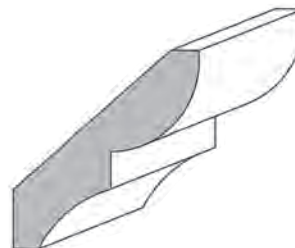
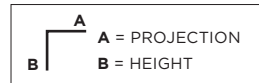

135 - 5/8" (16mm) x 2-3/4"
(A = 1-7/8") (B = 2")
SPECIES: W/W PINE



136 - 5/8" (16mm) x 2-1/4" (57mm)
(A = 1-7/16") (B = 1-3/4")
SPECIES: W/W PINE

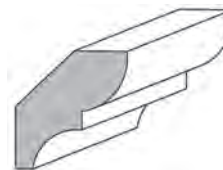

138 - 5/8" (16mm) x 1-5/8" (41mm)
(A = 1-1/8") (B = 1-3/16")
SPECIES: W/W PINE



141 - 1" (25mm) x 1" (25mm)
SPECIES: W/W



142 - 3/4" (19mm) x 3/4" (19mm)
SPECIES: W/W OAK PINE
MAPLE



143 - 5/8" (16mm) x 5/8" (16mm)
SPECIES: W/W



144 - 1/2" (13mm) x 1/2" (13mm)
SPECIES: W/W

BASE CAPS



121 - 11/16" (17mm) x 1-3/8" (35mm)
SPECIES: W/W PINE

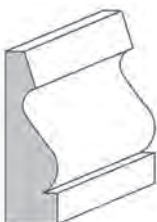

123 - 9/16" (14mm) x 1-3/4" (44mm)
SPECIES: W/W OAK



125 - 1-1/16" (27mm) x 1-1/2" (38mm)
SPECIES: W/W OAK PINE MAPLE

ASTRAGALS, BATTENS, FASCIAS, WINDOW MULLIONS



150 - 9/16" (14mm) x 2-1/4" (57mm)
SPECIES: W/W



151 - 3/4" (19mm) x 1-5/8" (41mm)
SPECIES: W/W

ASTRAGALS, BATTENS, FASCIAS, WINDOW MULLIONS

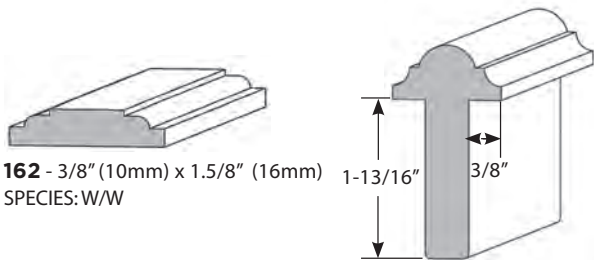

162 - 3/8" (10mm) x 1.5/8" (16mm)
SPECIES: W/W

215 - 1-1/4" (32mm) x 2-7/16" (62mm)
SPECIES: W/W PINE



164 - 3/8" (10mm) x 1-3/8" (35mm) SPECIES: W/W
3/8" (10mm) x 1-1/8" (29mm) SPECIES: W/W

165 - 1/2" (13mm) x 1-1/2" (38mm) SPECIES: W/W

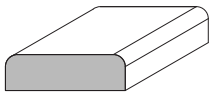

166 - 3/8" (10mm) x 1-1/4" (32mm)
SPECIES: W/W

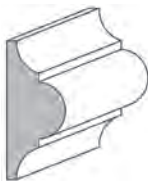

211 - 3/4" (19mm) x 1-3/4" (44mm)
SPECIES: W/W PINE

212 - 3/4" (19mm) x 1-3/8" (35mm)
SPECIES: W/W PINE MAHOGANY WALNUT

213 - 7/16" (11mm) x 3/4" (19mm)
SPECIES: W/W MAPLE MAHOGANY WALNUT

SHINGLE MOULDS/BRICK MOULD

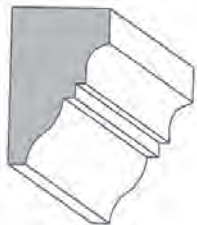

152 - 1-7/32" (31mm) x 1-11/16" (42mm)
SPECIES: W/W PINE MAPLE

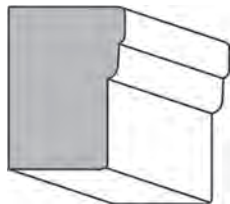

154 - BRICK MOULD
1-1/4" (32mm) x 1-3/4" (44mm)
SPECIES: PINE

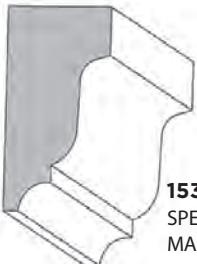

153 - 1-5/16" (33mm) x 2-3/8" (60mm)
SPECIES: W/W OAK PINE MAPLE MAHOGANY WALNUT

SHINGLE MOULD

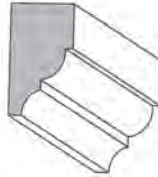

157 - 3/4" (19mm) x 1-1/4" (32mm)
SPECIES: W/W OAK PINE MAPLE MAHOGANY EZ BEND

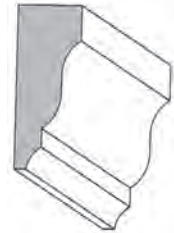

158 - 3/4" (19mm) x 1-3/4" (44mm)
SPECIES: W/W OAK PINE MAPLE CHERRY WALNUT EZ BEND

CHAIR RAILS

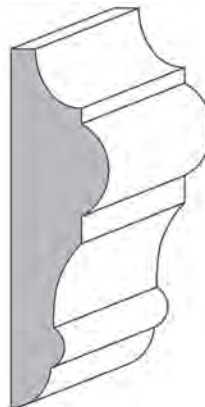

186 - 3/4" (19mm) x 3" (76mm)
SPECIES: W/W EZ BEND

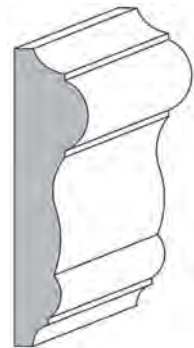

181 - 1" (25mm) x 3-5/8" (92mm)
SPECIES: W/W

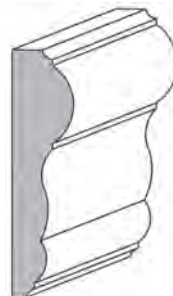

187 - 5/8" (16mm) x 2-1/2" (64mm)
SPECIES: W/W MAPLE

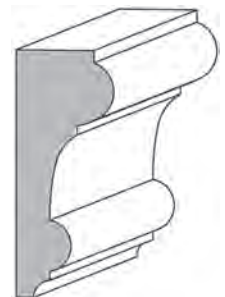

189 - 1" (25mm) x 2-1/2" (64mm)
SPECIES: W/W MAPLE MAHOGANY WALNUT

CHAIR RAILS

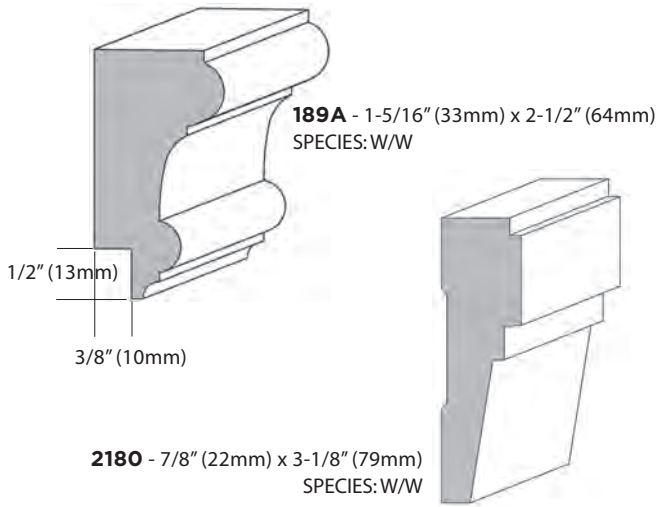

189A - 1-5/16" (33mm) x 2-1/2" (64mm)
SPECIES: W/W

2180 - 7/8" (22mm) x 3-1/8" (79mm)
SPECIES: W/W

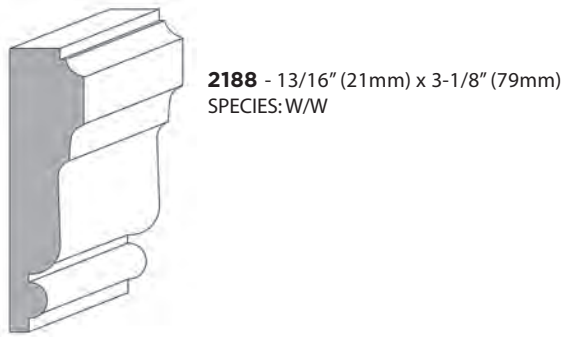

2188 - 13/16" (21mm) x 3-1/8" (79mm)
SPECIES: W/W

GLASS BEADS, SHELF EDGES & CORNER GUARDS



200 - 1-5/16" (33mm) x 1-5/16" (33mm)
SPECIES: W/W



201 - 1-1/8" (29mm) x 1-1/8" (29mm)
SPECIES: W/W

MDF BEADBOARD

Brenlo is pleased to offer the following stock paneling products for your convenience.



1) Classic "w" bead 3/8" (10mm) x 4' x 8'
MDF Sheets Bead is 1-1/2" (38mm) on
centre.



2) Standard beadboard 1/2" (13mm) x 4' x
8' MDF Sheets
Bead is 2" (51mm) on centre.



3) Antique "V" Groove 1/2" (13mm) x 4' x 8'
MDF Sheets
V Groove is 3" (76mm) on centre.

GLASS BEADS, SHELF EDGES & CORNER GUARDS



190 - 1/2" (13mm) x 9/16" (14mm)
SPECIES: W/W OAK



191 - 3/8" (10mm) x 3/8" (10mm)
SPECIES: W/W OAK PINE MAPLE
MAHOGANY WALNUT

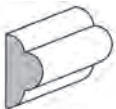

195 - 3/8" (10mm) x 3/4" (19mm)
SPECIES: W/W MAPLE



197 - 1/4" (6mm) x 3/4" (19mm)
SPECIES: W/W

**Custom bead and v-groove
sheets available upon request.**

TONGUE & GROOVE PANELING

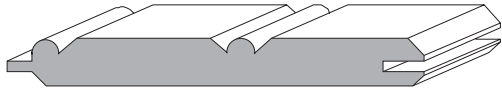

145 - 3/8" (10mm) x 3-1/8" (79mm)
REVERSIBLE - 4.17 LF = 1 sq. ft. coverage
SPECIES: W/W PINE

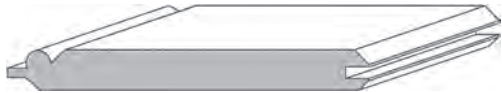

145S - 3/8" (10mm) x 3-1/8" (79mm)
4.17 LF = 1 sq. ft. coverage
SPECIES: W/W



146 - 3/4" (19mm) x 3-1/2" (89mm)
3.69 LF = 1 sq. ft. coverage
SPECIES: PINE



146A - 3/4" (19mm) x 4-3/4" (121mm)
2.67 LF = 1 sq. ft. coverage
SPECIES: W/W

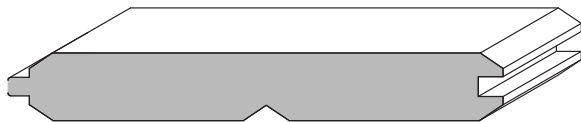

146B - 3/4" (19mm) x 5-1/2" (140mm)
2.28 LF = 1 sq. ft. coverage
SPECIES: PINE

TONGUE & GROOVE PANELING

NEW

147B-W - 3/4" (19mm) x 5-1/2" (140mm)
SPECIES: W/W

147B-P - 3/4" (19mm) x 5-1/2" (140mm)
SPECIES: PINE

2.34 LF = 1 sq. ft. coverage
1/8" Gap



NEW

147C-W - 3/4" (19mm) x 7-1/4" (184mm)
SPECIES: W/W

147C-P - 3/4" (19mm) x 7-1/4" (184mm)
SPECIES: PINE

1.68 LF = 1 sq. ft. coverage
1/8" Gap



NEW

148B-W - 3/4" (19mm) x 5-1/2" (140mm)
SPECIES: W/W

148B-P - 3/4" (19mm) x 5-1/2" (140mm)
SPECIES: PINE

2.28 LF = 1 sq. ft. coverage
1/2" Gap



NEW

148C-W - 3/4" (19mm) x 7-1/4" (184mm)
SPECIES: W/W

148C-P - 3/4" (19mm) x 7-1/4" (184mm)
SPECIES: PINE

1.71 LF = 1 sq. ft. coverage
1/2" Gap



INSPIRE SERIES

INSPIRE SERIES



NEW

INSP O1
1/2" (13mm) x 5" (127mm)
SPECIES: W/W
2.53 LF = 1 sq. ft. coverage



NEW

INSP O2
1/2" (13mm) x 5-7/16" (138mm)
SPECIES: W/W
2.31 LF = 1 sq. ft. coverage



NEW

INSP O3
3/4" (19mm) x 6-1/4" (159mm)
SPECIES: W/W
2 LF = 1 sq. ft. coverage



NEW

INSP O4
3/4" (19mm) x 7-1/8" (181mm)
SPECIES: W/W
1.75 LF = 1 sq. ft. coverage



NEW

INSP O5
3/4" (19mm) x 8-1/8" (181mm)
SPECIES: W/W
1.52 LF = 1 sq. ft. coverage

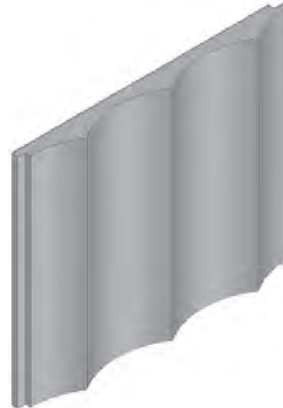

NEW

INSP O6
3/4" (19mm) x 8-9/16" (217mm)
SPECIES: W/W
1.44 LF = 1 sq. ft. coverage



NEW

INSP O7
3/4" (19mm) x 8-1/4" (210mm)
SPECIES: W/W
1.45 LF = 1 sq. ft. coverage



NEW

INSP O8
3/4" (19mm) x 7-7/8" (200mm)
SPECIES: W/W
1.52 LF = 1 sq. ft. coverage



NEW

INSP O9
3/4" (19mm) x 8-1/4" (210mm)
SPECIES: W/W
1.48 LF = 1 sq. ft. coverage

PANELING

DETAILS

Paneling can be made from a variety of mouldings and sheet products to achieve the look you want. This simple diagram shows a typical paneling detail and elevation to help you visualize the possibilities of what can be done with standard mouldings.

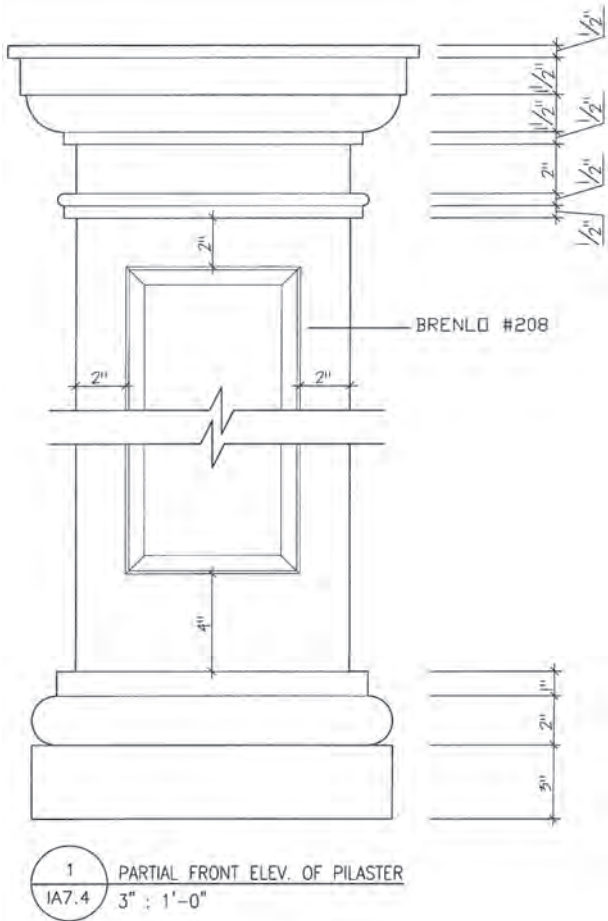

PANELING

DETAILS

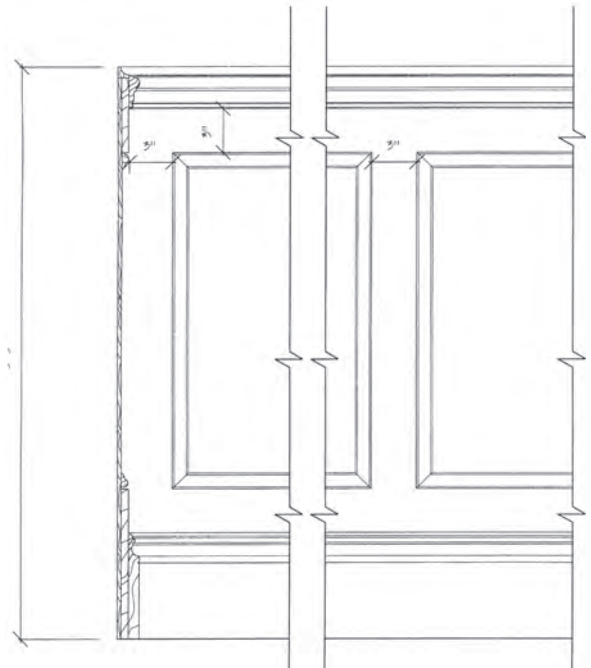
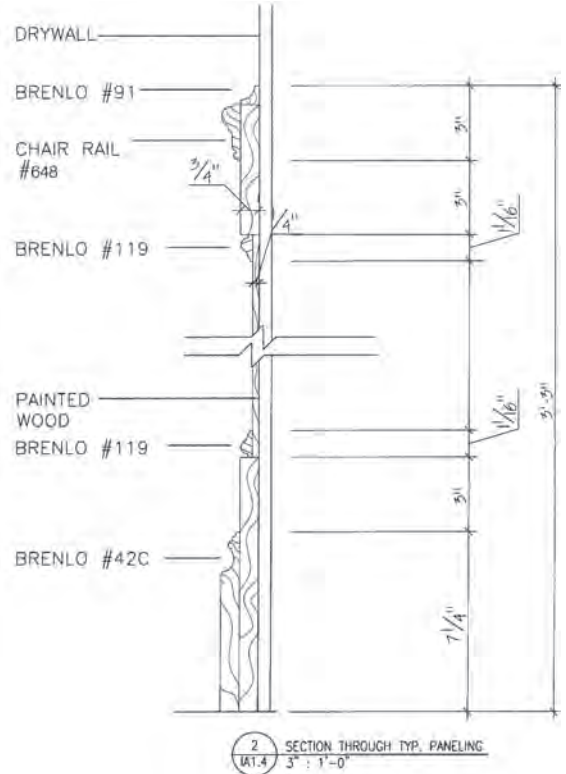

SPECIALTY ITEMS

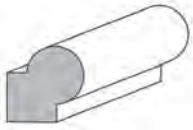

204 - CORNER BEAD

3/4" (19mm) x 3/4" (19mm)
SPECIES: W/W PINE

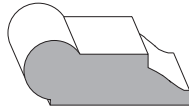

225 - PICTURE

11/16" (17mm) x 1-3/4" (44mm)
SPECIES: W/W

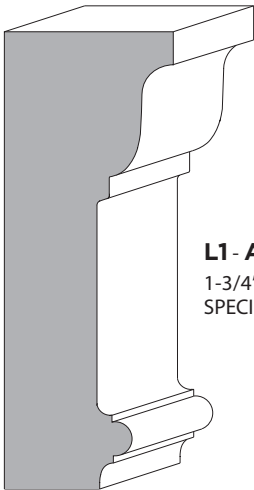

L1 - ARCHITRAVE

1-3/4" (44mm) x 4-3/4" (121mm)
SPECIES: W/W

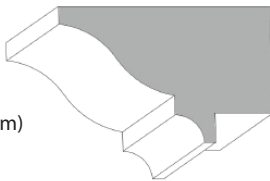

332 - ARCHITRAVE

1-3/4" (44mm) x 2-3/4" (70mm)
3/4" (19mm) Rabbet
SPECIES: W/W

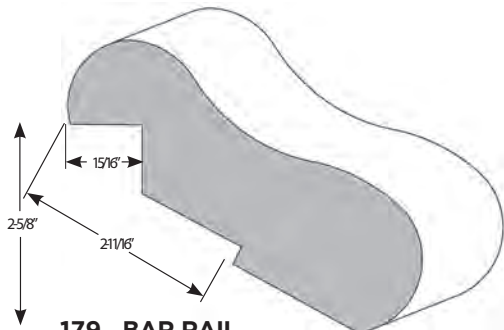

179 - BAR RAIL

1-3/4" (44mm) x 5-1/4" (133mm)
SPECIES: OAK MAPLE

SPECIALTY ITEMS

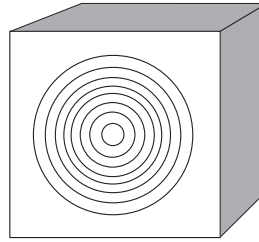

CORNER BLOCK

66 - 1" (25mm) x 4-1/2" (114mm) x 4-1/2" (114mm)
SPECIES: W/W

66A - 1" (25mm) x 3-3/4" (95mm) x 3-3/4" (95mm)
SPECIES: W/W

65 - 7/8" (22mm) x 3" (76mm) x 3" (76mm)
SPECIES: W/W

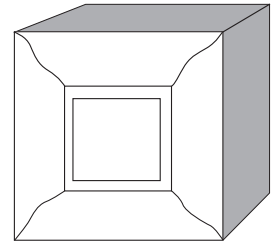

CORNER BLOCK

67 - 1-3/8" (35mm) x 4-1/2" (114mm) x 4-1/2" (114mm)
SPECIES: W/W

68 - 1-5/16" (33mm) x 3" (76mm) x 3" (76mm)
SPECIES: W/W

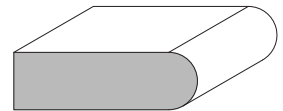

330 - FILIGREE

5/8" (68mm) x 2" (51mm)
SPECIES: W/W



329 - FILIGREE

3/8" (10mm) x 1-1/8" (29mm)
SPECIES: W/W PINE

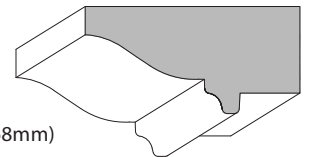

331 - ARCHITRAVE

1-1/4" (28mm) x 2-11/16" (68mm)
SPECIES: W/W

HALF ROUNDS

205D - 1-3/4" (44mm) x 3-1/2" (89mm)
SPECIES: W/W

205C - 1-1/2" (38mm) x 3" (76mm)
SPECIES: W/W

205B - 1-1/4" (32mm) x 2-1/2" (64mm)
SPECIES: W/W

205A - 1" (25mm) x 2" (51mm)
SPECIES: W/W PINE MAPLE

205 - 3/4" (19mm) x 1-1/2" (38mm)
SPECIES: W/W OAK PINE MAPLE

206 - 1/2" (13mm) x 1" (25mm)
SPECIES: W/W PINE

207 - 3/8" (10mm) x 3/4" (19mm)
SPECIES: W/W OAK PINE MAPLE

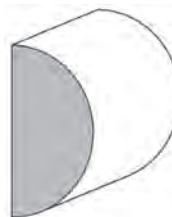

SPECIALTY ITEMS

171 - PILASTER

3/4" (20mm) x 6" (152mm)
SPECIES: W/W

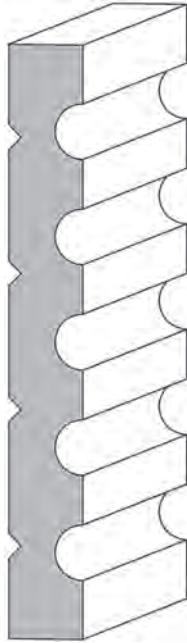
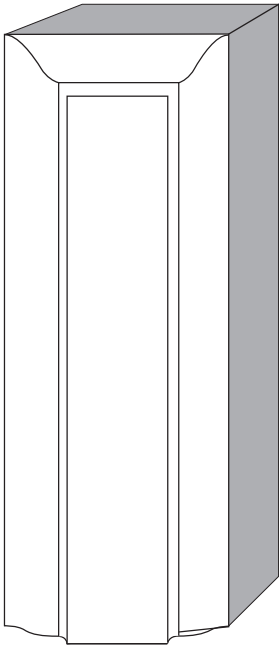

PLINTH BLOCK

337-4.5 - 1-3/8" (35mm) x 20" (508mm) x 4-1/2" (114mm)
SPECIES: W/W

337-375 - 1-3/8" (35mm) x 20" (508mm) x 3-3/4" (95mm)
SPECIES: W/W

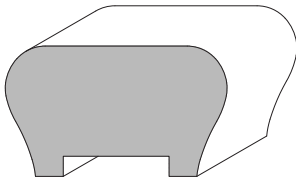

903 - HANDRAIL

1-5/8" (41mm) x 2-3/4" (70mm)
SPECIES: OAK

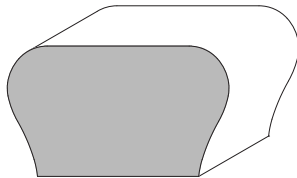

904 - HANDRAIL

1-5/8" (41mm) x 2-3/4" (70mm)
SPECIES: W/W OAK



930 - FILLER STRIP

1/4" (6mm) x 1-5/16" (33mm)
SPECIES: W/W

MDF & FINGER JOINT PROFILES

MDF 8915 COLONIAL BASE

1/2" (13mm) x 7-1/4" (184mm)

MDF 8095 - 1/2" (13mm) x 5-1/4" (140mm)

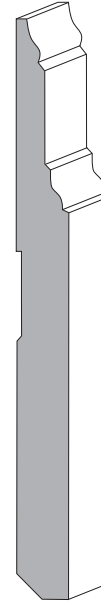
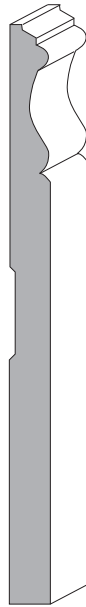

MDF8235 STEP BASE

5/8" (16mm) x 7-1/8" (181mm)

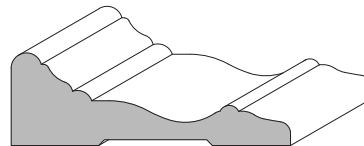

2700FJP - CASING

1" (25mm) x 3" (75mm)

Only available in Finger Joint Pine, one piece quick install



MDF 8954 - CASING

3/4" (19mm) x 3-1/2" (89mm)

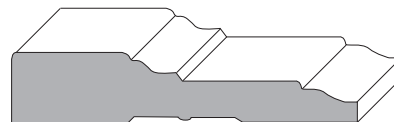

MDF 8031 - CASING

3/4" (19mm) x 3-1/2" (89mm)

DOORS

SILVER SERIES DOORS

Not all doors are created equal or meet Brenlo's quality standards. We offer an exclusive line of the finest premium wood doors not available from other suppliers.

STOCK DOORS: Our stock program is leading the way in offering quality, premium craftsmanship on demand to our clients. Our offerings include the following;

- Silver Series Raised 2 & 3 panel doors
- Shaker 1 & 2 panel doors
- Slab doors

All of these doors come 1 3/4" thick and are offered in 80", 84", 90" & 96" Heights. The available widths are 16"-36" widths (2 increments).

We also carry a budget friendly door style; Raised 2 Panel Moulded 80"H doors. These doors are carried in Hollow Core & Solid Core available.

Note: 80" height available only and are 1 3/8" thick

CUSTOM DOORS: Brenlo has a proven track record in providing custom and special order doors. We can produce doors in any size, species, style and finish you desire.

COMMERCIAL CUSTOM DOORS: We are a key supplier to many of the leading retail fixture and commercial millwork shops in Ontario for custom materials and doors. Doors for institutional, hotels, custom offices and the like require fire rated, fully engineered designs of the highest quality. We continue to meet these demanding standards and unique custom needs.

If you are looking for high performance truly unique custom doors, our door experts can have them designed and manufactured to suit, typically in 4 weeks.

PREMIUM QUALITY - "BEST" DOORS

These doors are manufactured to be everlasting, durable, sound resistant and aesthetically beautiful. They hold a finish extremely

SILVER SERIES

EXCLUSIVELY AT BRENLO

- SOLID WOOD, TRUE STILE & RAIL
- 2-PANEL AND 3-PANEL
- SEALED 6 SIDES AND BEVELED
- BRENLO "MATCHED" PROFILE

Available in:

- Stock: 1 3/4" - 80", 84", 90", 96"
- Widths from 16" - 36"

Engineered stiles and rails prevent warping

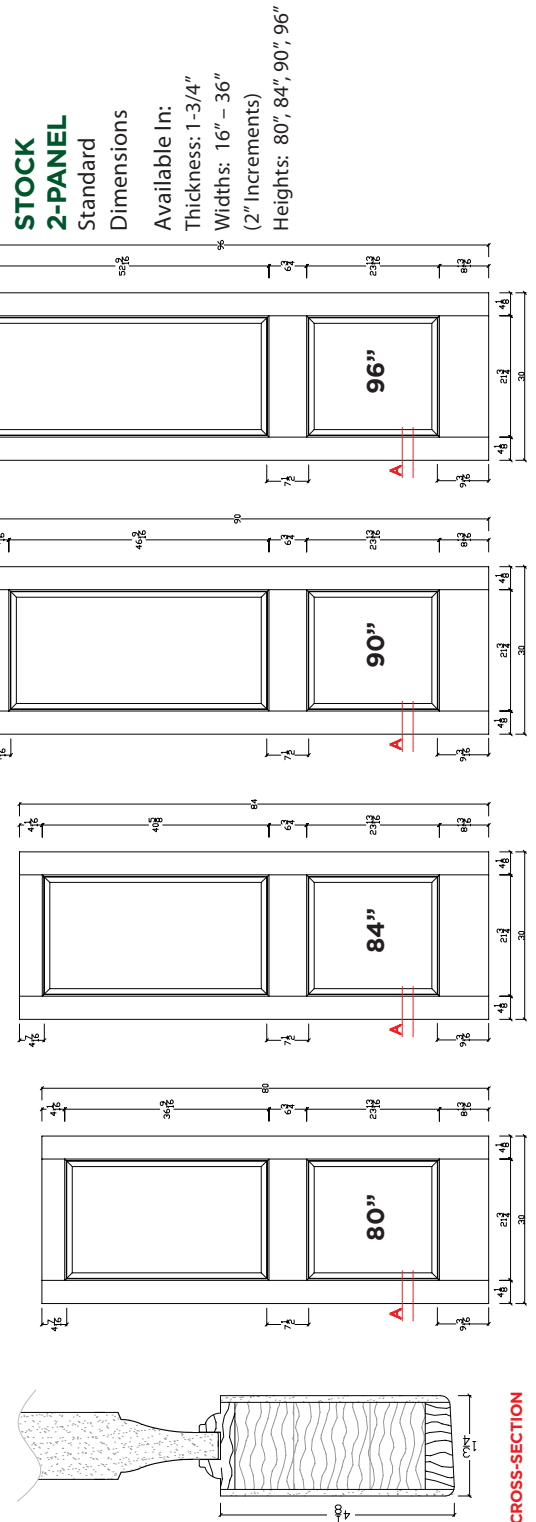

SILVER SERIES DOORS

STOCK 3-PANEL

Standard Dimensions

Available In:

Thickness: 1-3/4"

Widths: 16" - 36"

(2" Increments)

Heights: 80", 84", 90", 96"

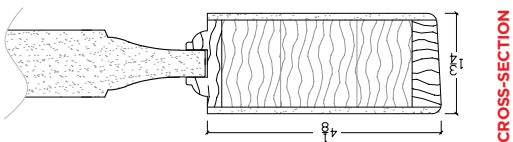
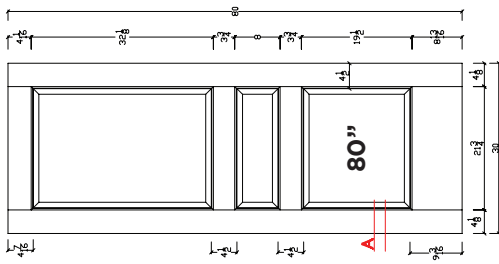
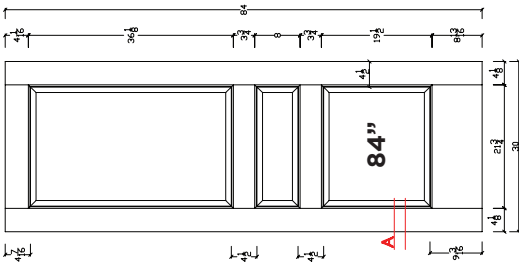
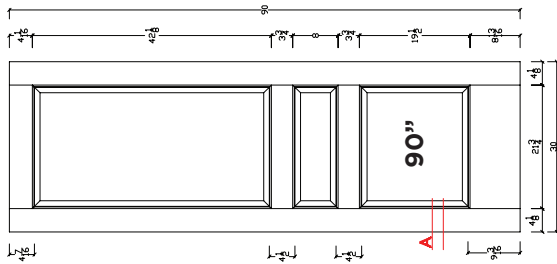
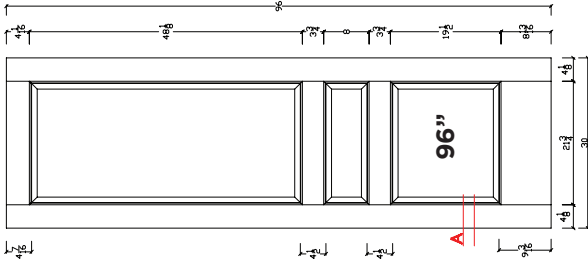

CROSS-SECTION

STOCK TD001 PANEL SHAKER DOORS

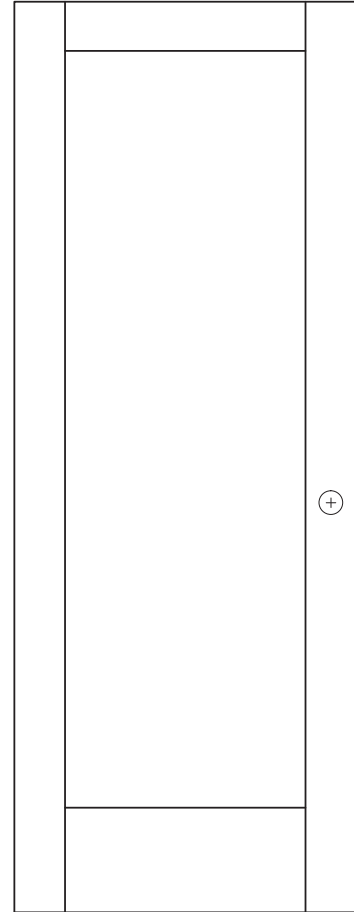

STOCK 1-PANEL TD001

Standard Dimensions

Available In:

Thickness: 1-3/4"

Widths: 16" - 36"

(2" Increments)

Heights: 80", 84", 90", 96"

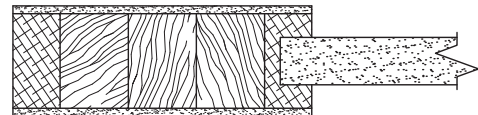

CROSS-SECTION

STOCK TD002 PANEL SHAKER DOORS

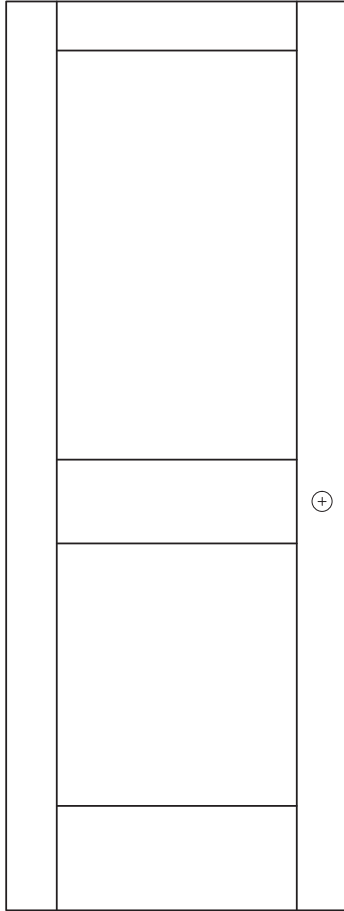

STOCK 2-PANEL TD002

Standard Dimensions

Available In:

Thickness: 1-3/4"

Widths: 16" – 36"

(2" Increments)

Heights: 80", 84", 90", 96"

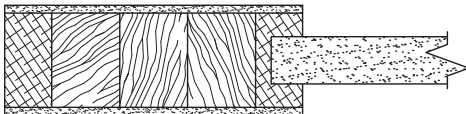

CROSS-SECTION

STOCK - MD001 SLAB DOORS

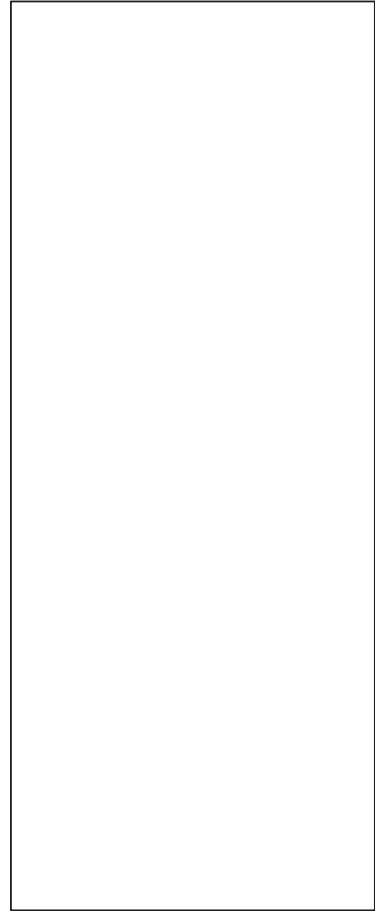

STOCK SLAB MD001

Standard Dimensions

Available In:

Thickness: 1-3/4"

Widths: 16" – 36"

(2" Increments)

Heights: 80", 84", 90", 96"

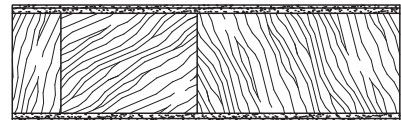

CROSS-SECTION

STOCK - 2 PANEL 80" CARRARA DOOR

CLASSIC NON STOCK DOORS

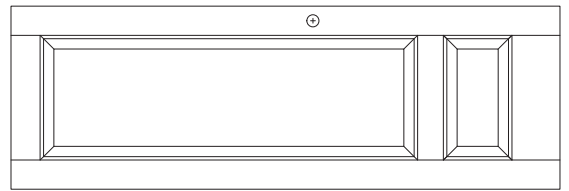
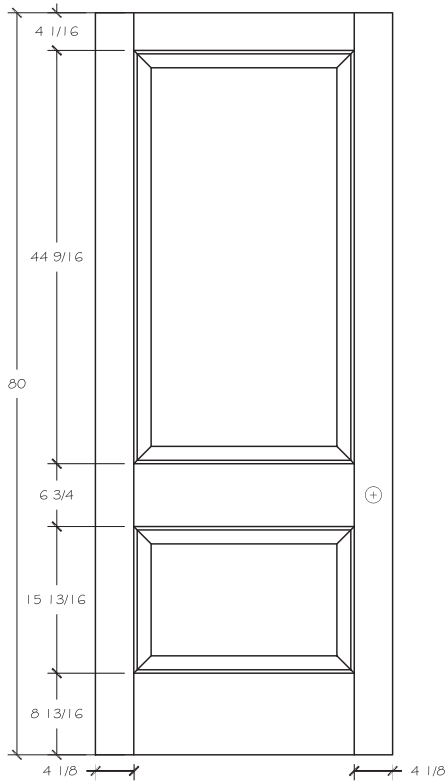

CD004

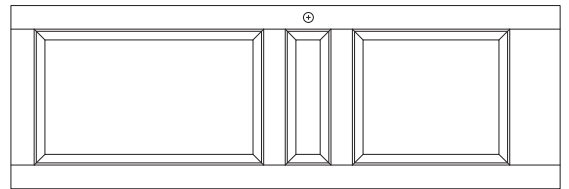

CD003

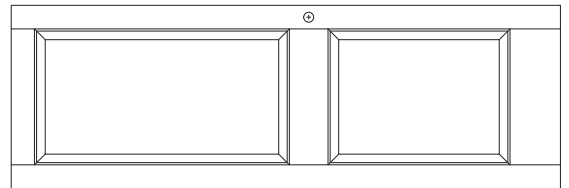

CD002

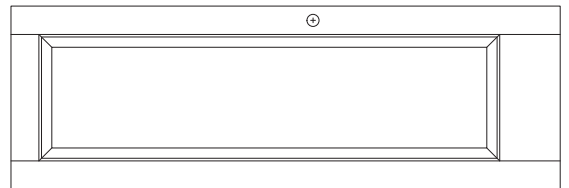

CD001

AVAILABLE IN: SOLID CORE - DCARSC8 80'
HOLLOW CORE - DCARHC8 80'
1-3/8"

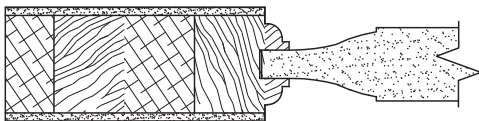

CROSS-SECTION

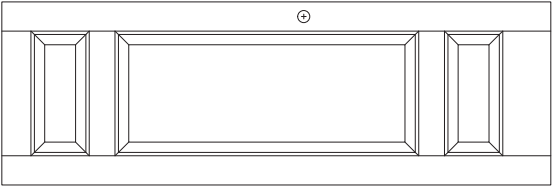

CD008

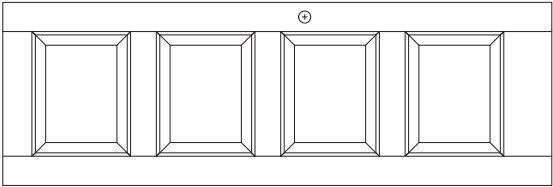

CD012

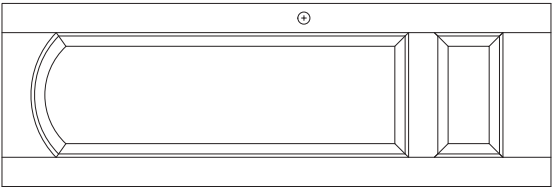

CD007

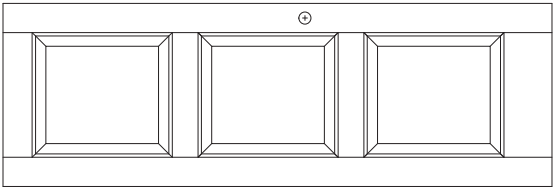

CD011

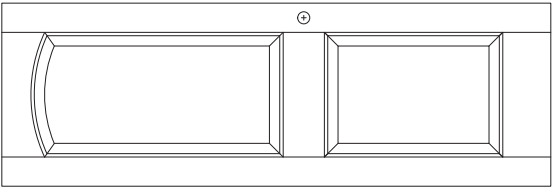

CD006

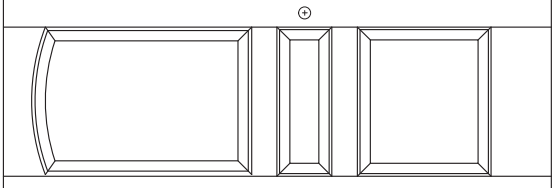

CD010

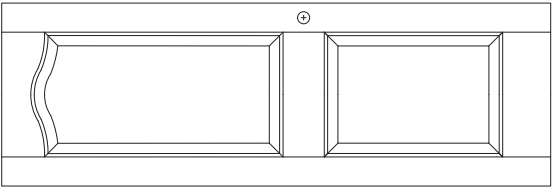

CD005

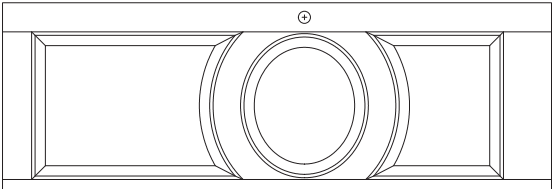

CD009

CLASSIC NON STOCK DOORS

TRANSITIONAL NON STOCK DOORS

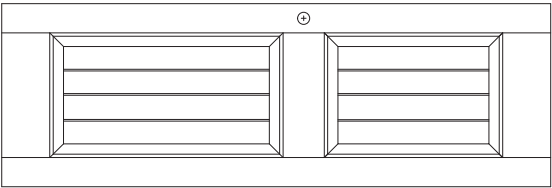

CD016

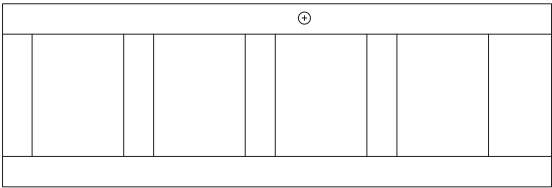

TD004

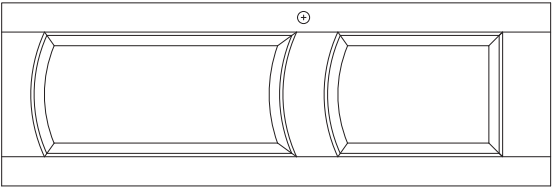

CD015

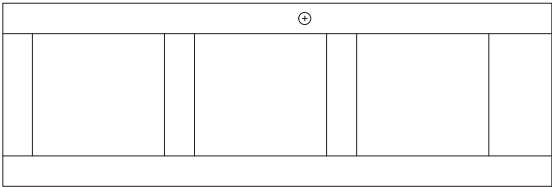

TD003

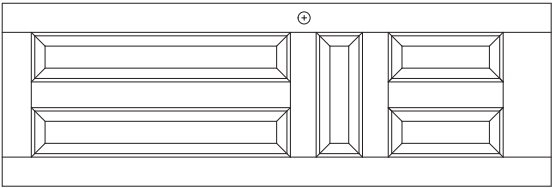

CD014

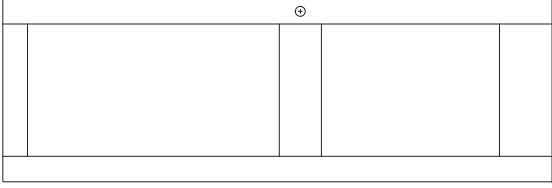

TD002

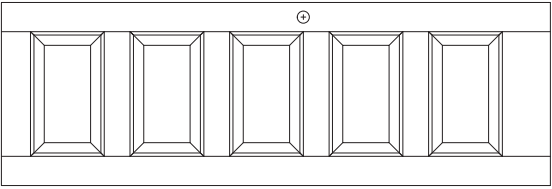

CD013

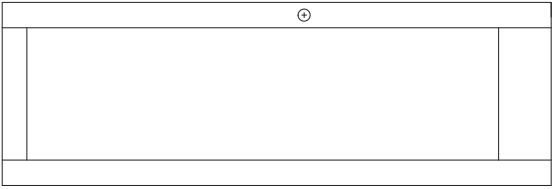

TD001

TRANSITIONAL NON STOCK DOORS

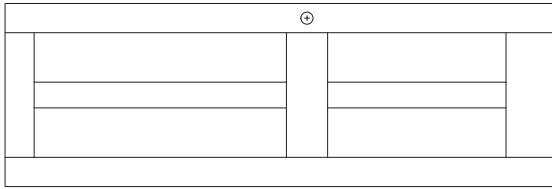

TD008



TD007

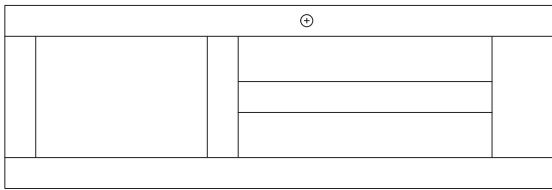

TD006

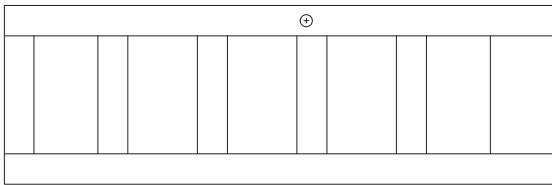

TD005

TRANSITIONAL NON STOCK DOORS

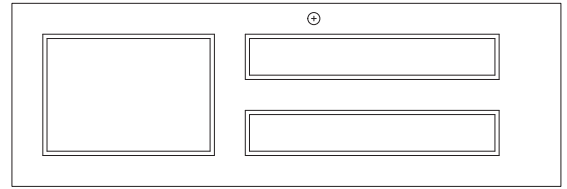

TD012

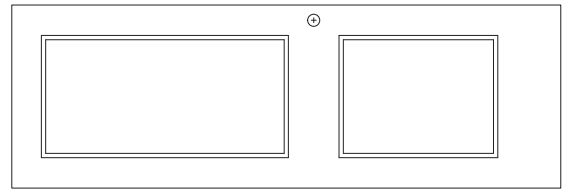

TD011

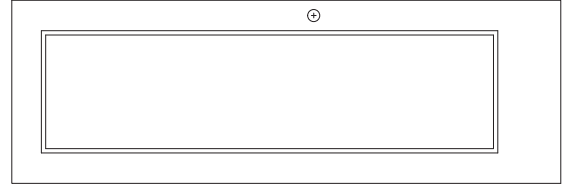

TD010

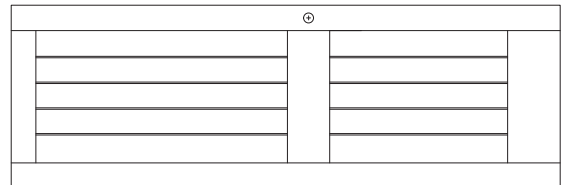

TD009

TRANSITIONAL NON STOCK DOORS

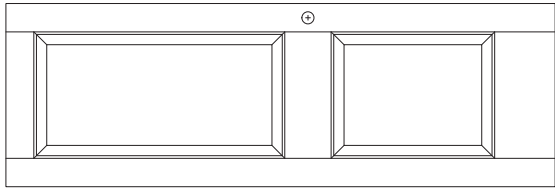

TD016

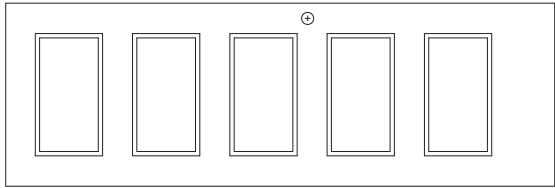

TD015

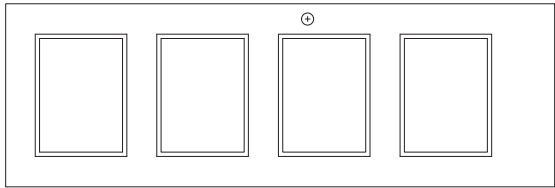

TD014

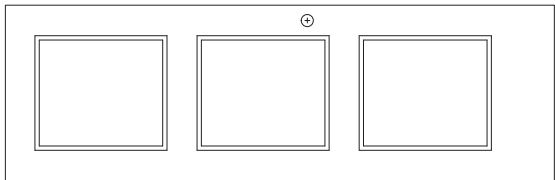

TD013

MODERN NON STOCK DOORS

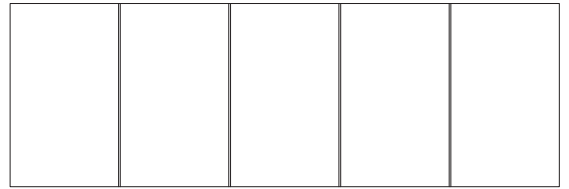

MD004

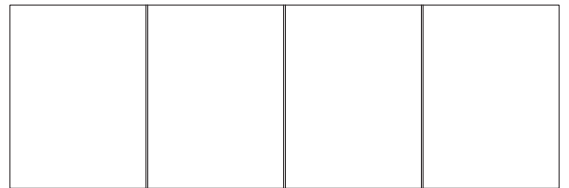

MD003

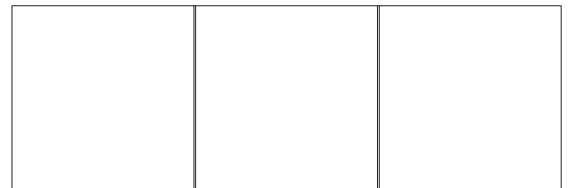

MD002

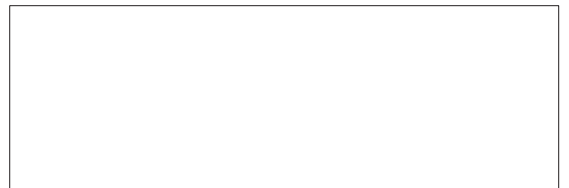

MD001

MODERN NON STOCK DOORS

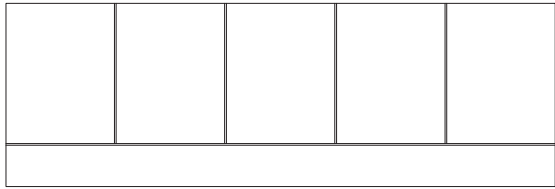

MD007-L

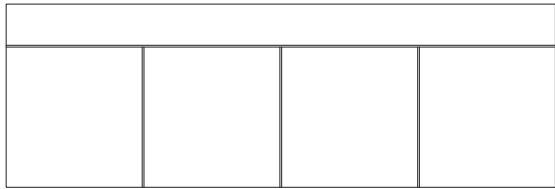

MD006-R

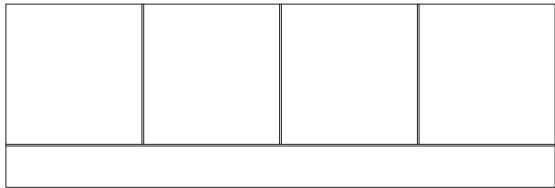

MD006-L

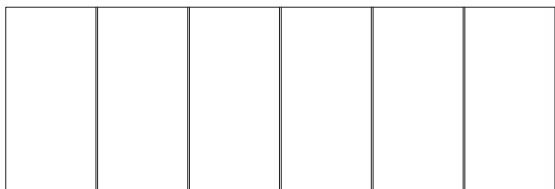

MD005

MODERN NON STOCK DOORS

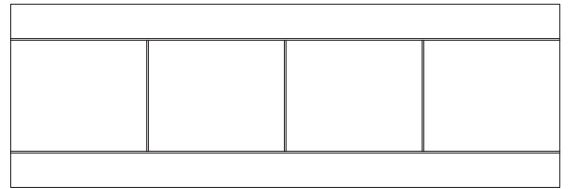

MD009

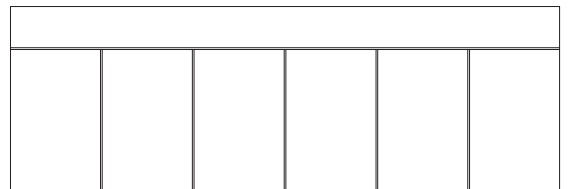

MD008-R

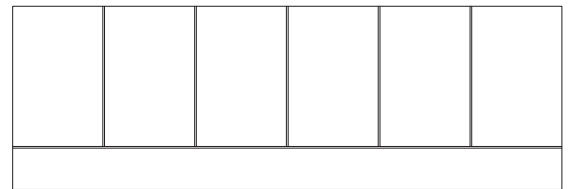

MD008-L

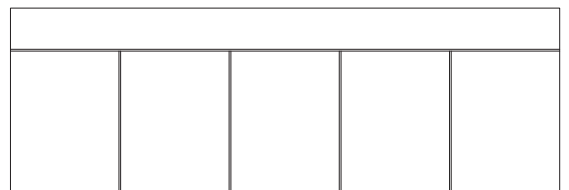

MD007-R

MODERN NON STOCK DOORS

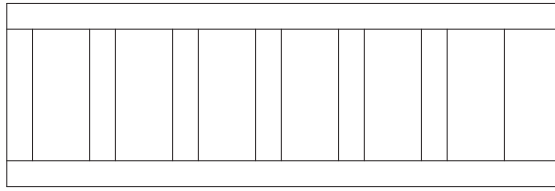

MD013

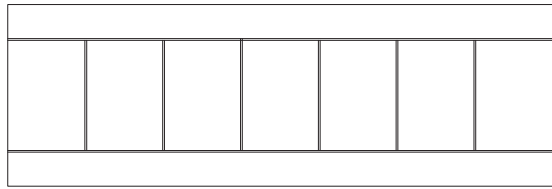

MD012

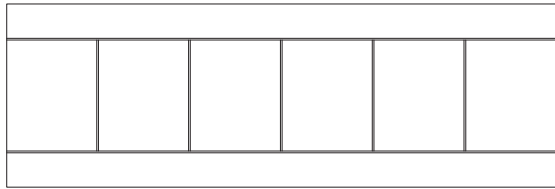

MD011

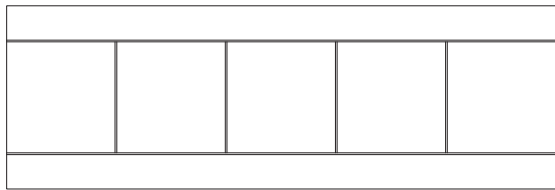

MD010

MODERN NON STOCK DOORS

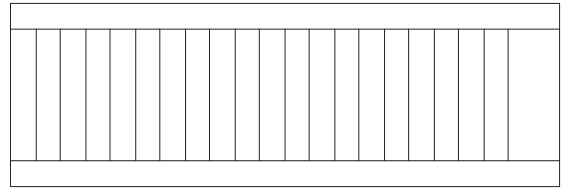

MD017

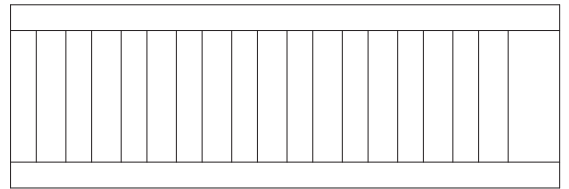

MD016

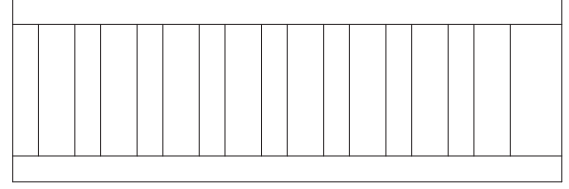

MD015

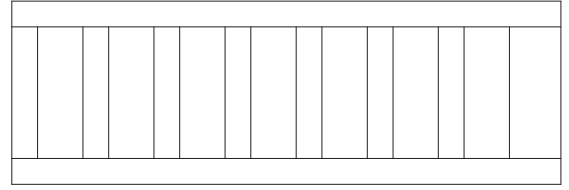

MD014

MODERN NON STOCK DOORS

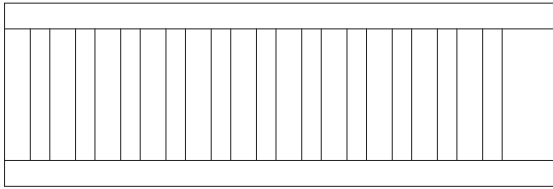

MD018

FRENCH NON STOCK DOORS

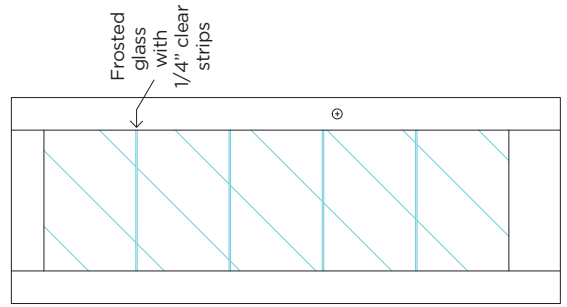

FD004

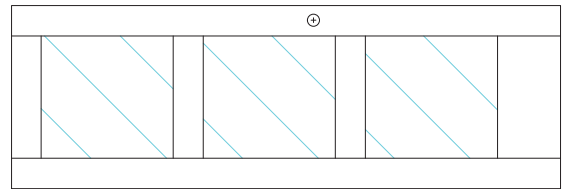

FD003

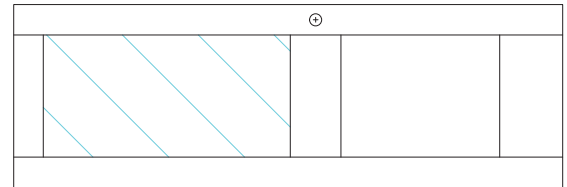

FD002

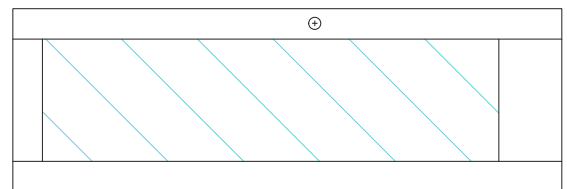

FD001

FRENCH NON STOCK DOORS

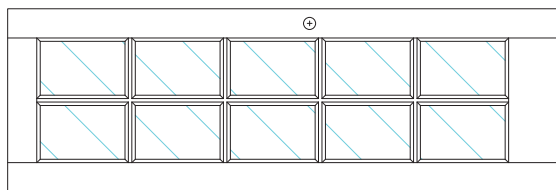

FD009

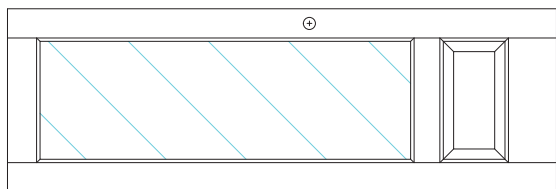

FD008

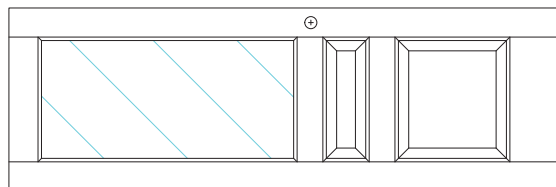

FD007

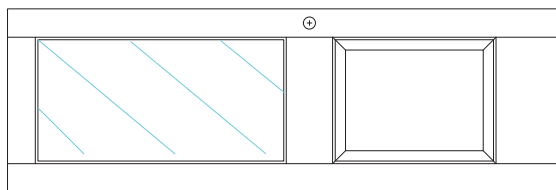

FD006

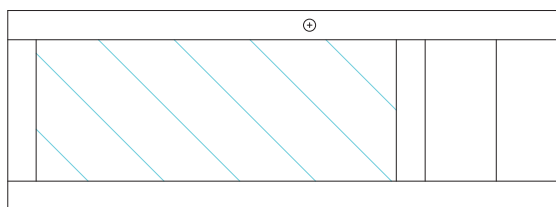

FD005

DOOR HARDWARE MISCELLANEOUS IN-STOCK HARDWARE

HINGES



All hinges come standard with Butt Tips

Premiere Butt Tip Hinges - Bright Brass, Satin Nickel, Plain Bearing, Oil Rubbed Bronze, Antique Nickel

3" X 3" (2.4mm thickness) - Plain Bearing

3 1/2" X 3 1/2" (3.1mm thickness) - Ball Bearing

4" X 4" (3.4mm thickness) - Ball Bearing

DOOR HARDWARE

IN-STOCK STANDARD LEVER HANDLE LATCH SETS
DUMMY LEVER SETS



DOOR CLOSER

up to 36" x 84" 600 Series, ALUM (55-100 LBS)



BULLET CATCH

w/Full Lip Strike, satin nickel, antique nickel, oil rubbed bronze



3 1/8" SPRING DOOR STOP

satin nickel, antique nickel, oil rubbed bronze



2 7/8" DIECAST DOOR STOP

satin nickel, antique nickel, oil rubbed bronze



6" FLUSH BOLT

Sq. End, satin nickel, antique nickel, oil rubbed bronze

SPECIAL ORDER

Reach out to your Brenlo Representative for special order hardware, Brenlo can provide hardware pricing from all major brands.

- KN Crowder
- Emtek
- Schlage
- Weiser
- Taymor
- Aarum
- Baldwin & more

GRADING VENEERS

The term “grade” describes the natural characteristics allowed in each veneer or ply. The face ply in hardwood plywood is exposed, and therefore, the face grade defines the panel appearance and quality. Some panels have a face made of highly matched veneers with uniform colour and grade. Other panels may include more character marks and colour variation to comply with the desired appearance.

FACE GRADES

AA Best quality face is used where minimal defects are required for doors, architectural paneling, and fine furniture.

A AA is not required, but appearance is important for cabinets, case goods and general millwork.

B Natural characteristics and appearance are desirable.

C, D, E Solid face with unlimited colour variation. C, D, and E respectively allow repairs in increasing sizes.

TERMINOLOGY:

PC Particle Core
VC Veneer Core

RED OAK - FLAT CUT

Stain Grade

1/4" X 4 FT X 8 FT – G1S – P.C. – A-Face

1/2" X 4 FT X 8 FT – G1S – P.C. – A-Face

3/4" X 4 FT X 8 FT – G1S – P.C. – A-Face

3/4" X 4 FT X 8 FT – G2S – P.C. – A-Face

3/4" X 4 FT X 8 FT – G2S – V.C. – A-Face

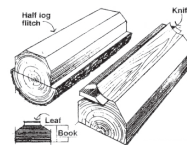

Plain Sliced or Flat Sliced

MAPLE - ROTARY CUT

Stain Grade / Paint Grade

1/4" X 4 FT X 8 FT – G1S – V.C. – A-Face

1/2" X 4 FT X 8 FT – G2S – P.C. – A-Face

1/2" X 4 FT X 8 FT – G2S – V.C. – A-Face

3/4" X 4 FT X 8 FT – G2S – P.C. – A-Face

3/4" X 4 FT X 8 FT – G2S – V.C. – A-Face



MAPLE - FLAT CUT

Stain Grade

1/4" X 4 FT X 8 FT – G1S – P.C. – A-Face

1/2" X 4 FT X 8 FT – G1S – P.C. – A-Face

3/4" X 4 FT X 8 FT – G1S – P.C. – A-Face

WALNUT - FLAT CUT

Stain Grade

1/4" X 4 FT X 8 FT – G1S – P.C. – A-Face

1/2" X 4 FT X 8 FT – G1S – P.C. – A-Face

3/4" X 4 FT X 8 FT – G1S – P.C. – A-Face

BIRCH - ROTARY CUT

Paint Grade (Putty Patch)

1/2" X 4 FT X 8 FT – G1S – V.C.

3/4" X 4 FT X 8 FT – G1S – V.C.

KHAYA MAHOGANY - FLAT CUT

Stain Grade

1/4" X 4 FT X 8 FT – G1S – P.C. – A-Face

1/2" X 4 FT X 8 FT – G1S – P.C. – A-Face

3/4" X 4 FT X 8 FT – G1S – P.C. – A-Face

WHITE OAK - RIFT CUT

Stain Grade - Slipmatch

1/4" X 4 FT X 8 FT – G1S – P.C. – A-Face

1/2" X 4 FT X 8 FT – G1S – P.C. – A-Face **NEW**

3/4" X 4 FT X 8 FT – G1S – P.C. – A-Face

LEGEND

P.C. - Particle Core	V.C. - Veneer Core
G1S - Good One Side	G2S - Good Two Sides

Brenlo can source and supply most plywoods required for your project

SHEET GOODS

IN-STOCK AT BRENLO

VENEER EDGE TAPE

Birch, Cherry, Mahogany, Red Oak, White Melamine, White Oak, Black Walnut

CREZON (MDO)

(Exterior Plywood)
1/2" X 4' X 8' G1S
3/4" X 4' X 8' G1S

FLEX PLY

3/8" X 4' X 8' Short Grain Flex Ply
(Wiggleboard)

PREMIUM BOARD

MDF RANGER BRAND

1/4" X 4' X 8'
3/8" X 4' X 8'
1/2" X 4' X 8' *
5/8" X 4' X 8'
3/4" X 4' X 8' *
1" X 4' X 8'

OVERSIZED

M.D.F BOARD

3/4" X 4' X 9'
1/4" X 5' X 10'
1/2" X 5' X 10'
3/4" X 5' X 10'
3/4" X 5' X 12'

MASONITE BACKER

1/8" X 4' X 8'

SAUNA MATERIALS

Sauna Doors priced upon request.

SELECT CEDAR (WESTERN RED CEDAR)

Aromatic 12 sq. ft. per bundle
1 X 4 T & G (select)
1 x 4
1 X 6
2 X 4
2 X 6
2 X 8
Cedar Sauna Handles
Shim Shingles
Aluminum Sauna Foil

DECKING

IPE DECKING (TABEBUIA SPP)

IPE: (tabebuia) is a South American Hardwood that is naturally strong, durable, and decay/termite resistant. The decking material is knot free and needs no preservative treatment. It can be left "raw" and will turn a natural grey colour or can be coated with a stain of your choice (IPE OIL recommended). Unlike other suppliers, Brenlo machine sands one side of all stock IPE to provide the user with a consistent smooth visible surface.

Performance: IPE is one of the densest hardwoods on earth three times the hardness of oak. As a result, it remains smooth and splinter free. Unlike soft woods, water absorption is slow and therefore will not cup, bow, or twist like other woods.

Applications: Ideal for patios and decks, piers, boat docks, outdoor furniture, walkways, bridges and paths, pool side benches and decks.

- AIR DRIED – EASED 4 EDGES
- SANDED ONE SIDE

NOMINAL SIZE 1 x 4 x 8 – 20 ft

5/4 x 6 x 8 – 20 ft Stock Inventory

Below is subject to availability:

1 x 4	2 x 2	4 x 4
1 x 6	2 x 4	6 x 6
1 x 8	2 x 6	8 x 8
1 x 10	2 x 8	T-Connect Pieces
1 x 12	2 x 10	
2 x 2	2 x 12	

"Hidden" Deck Brackets available in: Powder Coat Galvanized, Stainless Steel

EB-TY Fasteners available with groove option Contractor boxes of 100pcs with hardware

Special order lead time -10 days.

FROGBOARD™ - NEW!

REVOLUTIONARY WOOD ALTERNATIVE



LIMITED LIFETIME WARRANTY

FROGBOARD is weather-resistant and comes with a limited lifetime warranty.

WATER-RESISTANT

FROGBOARD is resistant to UV, weather, rot, and pests. It is 100% water-resistant, thus, traditional wood maintenance and replacements are not needed.

CAN BE PAINTED OR STAINED

Unlike other wood alternatives available, FROGBOARD can be painted or stained. We recommend using water-based paint, stain, or sealer on FROGBOARD products. Please refer to www.brenlo.com/frogboard for coating recommendations.

INDISTINGUISHABLE FROM NATURAL WOOD

FROGBOARD looks like natural wood and comes in both smooth or grained texture.



THERMOFORMABLE

FROGBOARD can be bonded by heat and compression (heat-sealing).

With heat, the sheets can be bent, molded, or curved. It is a perfect fit for curved designed accents, furniture, and other applications.

MACHINABLE

FROGBOARD is workable with standard woodworking tools and doesn't require additional substitutes. It is easy on screwing, nailing, cutting, drilling, sanding, and milling.

SUSTAINABLE

FROGBOARD is a green alternative that relies on dried rice hulls and is yet another initiative from Brenlo to take sustainability as a priority. It is free of phenol, formaldehyde, and adhesives. It is 100% recyclable.

FROGBOARD SKUs IN-STOCK

PFROGBD - 41034	Frogboard 3/4" x 4' x 10' Smooth/Wood Grain
PFROGBD - 41212	Frogboard 1/2" x 4' x 12' Smooth/Wood Grain
PFROGBD - 41234	Frogboard 3/4" x 4' x 12' Smooth/Wood Grain
PFROGBD - 4812	Frogboard 1/2" x 4' x 8' Smooth/Wood Grain
PFROGBD - 4814	Frogboard 1/4" x 4' x 8' Smooth/Wood Grain
PFROGBD - 4834	Frogboard 3/4" x 4' x 8' Smooth/Wood Grain
PFROGTR - 1X10X16	Frogboard 3/4" x 9 1/4" x 16' Smooth/Wood Grain
PFROGTR - 1X12X16	Frogboard 3/4" x 11 1/4" x 16' Smooth/Wood Grain
PFROGTR - 1X6X16	Frogboard 3/4" x 5 1/2" x 16' Smooth/Wood Grain
PFROGTR - 1X8X16	Frogboard 3/4" x 7 1/4" x 16' Smooth/Wood Grain

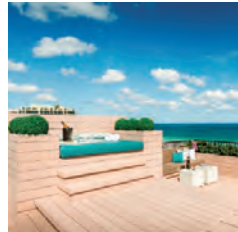

Scan to know more



EXTERIOR TRIM BOARD

BRENLO'S PRIMED WHITE FASCIA BOARD SIZES

- 1" x 6" (3/4" x 5-1/2") x 16 ft
- 1" x 8" (3/4" x 7-1/4") x 16 ft
- 1" x 10" (3/4" x 9-1/4") x 16 ft

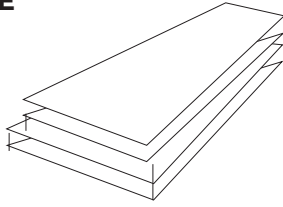

TRIMBOARD (UNPRIMED):

- 1" x 6" (3/4" x 5-1/2") x 16'
- 1" x 8" (3/4" x 7-1/4") x 12' & 16'
- 1" x 10" (3/4" x 9-1/4") x 12' & 16'
- 1" x 12" (3/4" x 11-1/4") x 12'

SHEETS:

- | | |
|------------------------|------------------------|
| 1/4" (6mm) x 4' x 8' | 3/4" (19mm) x 4' x 8' |
| 1/2" (13mm) x 4' x 8' | 3/4" (19mm) x 4' x 10' |
| 1/2" (13mm) x 4' x 12' | 3/4" (19mm) x 4' x 12' |



TAKE IT OUTSIDE!

TREATED EXTERIOR PANEL

- Limited EXP & Contraction
- Moisture Resistant exterior panel for paint-grade applications
- Resists rot and termites; treated with zinc borate
- No added formaldehyde
- Phenolic-bonded for moisture resistance and durability
- 5-year limited warranty
- Patented, proprietary TECTM manufacturing technology

Size (nominal)	Thickness (=-/ 0.005")				
	1/2"	5/8"	3/4"	1	1-1/4"
4' x 8' (49" x 97")	•	A	•	A	A
4' x 16' (49" x 194")	A	A	A	A	A
2' x 16' (25" x 194")	A	A	•	A	A

Fascia, Columns, Soffits, Window Treatments

- Stocked Inventory
- A** Available as special order

NOVAWOOD

Novawood is Ash decking and siding lumber that has been thermally modified using high temperatures (1800 C – 2120 C), water vapour and pressure.

Through this treatment, Novawood achieves unparalleled stability and durability for exterior applications.

The thermal modification process takes 48–96 hours, depending on species, thickness and initial moisture content. Absolutely no chemical substances are used in the production process.



End Match Technology

This revolutionary technique allows for 100% usage of each board. The seams are NOT required to rest on support joists. This saves time measuring and cutting and gives a clean hardwood flooring look. Not to mention the design possibilities that are only limited by your imagination.

Hidden Clip Technology

The Novawood deckboards we carry in stock are pre-grooved and joined together with custom hidden clips. These clips allow for perfect board spacing, clean lines and minimal hardware.

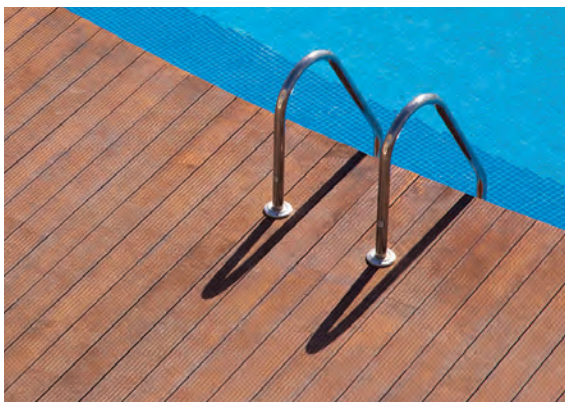

Key Features:

Why Choose Novawood?

- 100% Natural – Absolutely no chemicals used during the entire Thermowood process.
- Environmentally Responsible – Harmless to human beings and all living species. Environmentally friendly, healthy, recyclable and strong.
- Durable & Stable – Performs in all weather conditions, outlasting many other species.
- Sustainable – Produced from sustainable forests. FSC Certified.
- Easy – Light weight, easy on tooling and machinery; planks are 100% usable.
- Homogeneous – Colour of wood is consistent throughout.
- Comfortable – 25% more acoustic and heat isolated than non-thermally modified wood. No hot feet, unlike plastic decking.
- Safe – 30% more fire resistant than normal lumber. Insect habitation is completely prevented. Resistant to decay and fungal growth.

CONVERSION CHART

Fraction	Decimal	MM	Fraction	Decimal	MM
1/64	0.0156	0.3969	33/64	0.5156	13.0969
1/32	0.0313	0.7938	17/32	0.5313	13.4938
3/64	0.0469	1.1906	35/64	0.5469	13.8906
1/16	0.0625	1.5875	9/16	0.5625	14.2875
5/64	0.0781	1.9844	37/64	0.5781	14.6844
3/32	0.0938	2.3813	19/32	0.5938	15.0813
7/64	0.1094	2.7781	39/64	0.6094	15.4781
1/8	0.125	3.175	5/8	0.625	15.875
9/64	0.1406	3.5719	41/64	0.6406	16.2719
5/32	0.1563	3.9688	21/32	0.6563	16.6688
11/64	0.1719	4.3656	43/64	0.6719	17.0656
3/16	0.1875	4.7625	11/16	0.6875	17.4625
13/64	0.2031	5.1594	45/64	0.7031	17.8594
7/32	0.2188	5.5563	23/32	0.7188	18.2563
15/64	0.2344	5.9531	47/64	0.7344	18.6531
1/4	0.25	6.35	3/4	0.75	19.05
17/64	0.2656	6.7469	49/64	0.7656	19.4469
9/32	0.2813	7.1438	25/32	0.7813	19.8438
19/64	0.2969	7.5406	51/64	0.7969	20.2406
5/16	0.3125	7.9375	13/16	0.8125	20.6375
21/64	0.3281	8.3344	53/64	0.8281	21.0344
11/32	0.3438	8.7313	27/32	0.8438	21.4313
23/64	0.3594	9.1281	55/64	0.8594	21.8281
3/8	0.375	9.525	7/8	0.875	22.225
25/64	0.3906	9.9219	57/64	0.8906	22.6219
13/32	0.4063	10.3188	29/32	0.9063	23.0188
27/64	0.4219	10.7156	59/64	0.9219	23.4156
7/16	0.4375	11.1125	15/16	0.9375	23.8125
29/64	0.4531	11.5094	61/64	0.9531	24.2094
15/32	0.4688	11.9063	31/32	0.9688	24.6063
31/64	0.4844	12.3031	63/64	0.9844	25.0031
1/2	0.5	12.7	1	1	25.4

BRENLO CUSTOM SHOP

CUSTOM SHOP

Over the years Brenlo has become much more than just a wood moulding manufacturer. We focus on creating a unique product for our customers and in turn their clients. Our Custom Shop takes great pride in these products and solutions while in keeping with the vision of the project. We have once again expanded our manufacturing capabilities with the latest technology. We remain true to great craftsmanship and attention to detail. We now offer more Joinery and Bench-work type products. Some of the new products available are our specialty doors, over-sized porch brackets, courtroom and church pew components, solid wood laminated table/counter tops, C.N.C parts and components for the Store Fixture Industry.

Please call us for your next unique and challenging project; we can help you with it. See page 92 for examples of the craftsmanship our Custom Shop produces. If it's made of wood we can do it!



Brenlo will custom make solid wood laminated panels. Panels can be made in a variety of widths and lengths. Laminated panels are often used for bar tops, stair treads & other high use applications. These products can be made in virtually any species. Please contact our order desk or fax details and specifications of your requirements to us @ (416) 749-8969.

ARCHES & CURVES

Brenlo specializes in curved casings, backbands, crowns, baseboards, bar rails, chair rails and panel moulds.

Curves can be made from a template or from accurate measurements. Arches made from measurements for window casings tend to be the most accurate as they give a true consistent radius.

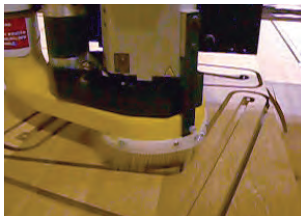

Our C.N.C.Router machining quarter cut white oak furniture components



Curved oak crowns, chair rails and base boards for wrapping of large oak columns

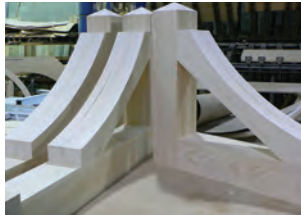

Architect designed large exterior pine porch brackets for a custom home builder



Another unique design of 3'x 4' porch brackets

VERTICAL CURVES

Typical arch types are as follows:

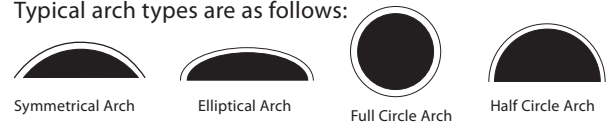

Please note all horizontal curves must be clearly specified as concave or convex applications.

HORIZONTAL CURVES

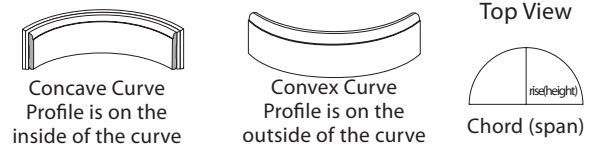

HOW TO MEASURE CURVES

To make an arch window casing you need to have only two critical measurements. These measurements are as follows:

- 1) The accurate chord (inside width) of the casing line
- 2) The accurate rise (height) from your horizontal line (chord) to the inside of your casing line For a cost effective alternative, we also offer some profiles custom run in EZ Bend.

WOOD SPECIES



Whitewood
(Poplar)



Red Oak



Eastern White Pine



Hard White Maple



American
Black Cherry



Genuine Mahogany

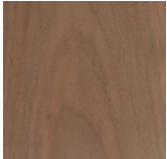

Black Walnut



Knotty Pine

Other Species

Quarter Cut Red Oak	European Steamed Beech
Rift Cut Red Oak	Burmese Teak
White Oak	Soft Maple
Quarter Cut White Oak	Red Pine
Rift Cut White Oak	Red Birch
African Mahogany	Alder
Jatoba (Brazilian Cherry)	IPE
North American Beech	Vertical Grain Fir



ENVIRONMENTAL COMMITMENT

Brenlo is well known for our commitment to sustainability and industry best practices when it comes to environmental compliance. We are FSC® Certified and have expert staff supporting our active involvement in the Canada Green Building Council, LEED building and AWMAC commercial standards

Respect for our natural resources and respect for the environment are two of the most important priorities at Brenlo Ltd. Our wood suppliers comply with all government regulations. Conservation of natural resources is also considered essential: hence, Brenlo's suppliers of wood products emphasize yield management by equipping their facilities with the latest technology available. Our suppliers are constantly seeking better ways to protect and sustain our natural resources that provide the raw material which we then mill and supply to you, our valued customer.

Brenlo's suppliers actively enforce all federal and regional Sustainable Forestry Initiatives, and support the standards set by the National Hardwood Lumber Association. These suppliers participate in, or meet the most rigid independent environmental certification programs including FSC certified products.

At Brenlo, we feel that it is our personal and professional responsibility to help sustain the forests, wildlife habitat and ecosystems that we depend on. It is our belief that a healthy environment and a sound and sustainable use of nature's treasures means a healthy future for all concerned.



The mark of responsible forestry



Brenlo is a proud supporter of



SERVICES WE OFFER

CONSISTENT QUALITY

You can trust that we will do what we say and meet or exceed your expectations when it comes to reliability and consistency.

FLEXIBLE DELIVERY MANAGEMENT

Brenlo offers options to pre-package and then deliver on site by floor, by product type (i.e. jambs only, casing & jambs, doors separately, baseboards last) or any method that meets your requirements.

CUSTOM MOULDING

If you don't see the design you are looking for, we will make it to order for you whether in small quantities, large volumes, special species, custom sizes.

HARDWOOD SPECIES

We stock an extensive assortment of North American quality hardwood and softwood, as well as exotic hardwood species in various grades and thicknesses.

DOOR MACHINING

Brenlo has specialized machinery so we can pre-machine any doors ordered from Brenlo for hinges and door hardware. Your installers will save time and have consistent fit and installation of every door. Please inquire about our low cost flat rate service per door.

ORDERING INFORMATION

DELIVERY CHARGE

Brenlo will apply a flat rate charge for each on-site load delivery within the GTA. Charges may apply for deliveries outside of Brenlo delivery boundaries. Please call the order desk to inquire

DELIVERY ACCESS

The customer is responsible for ensuring that there is adequate space available at the jobsite to receive the delivered products and that access to the area where the products are to be delivered is safe and free of obstacles. In the event that the Brenlo driver determines that access to the jobsite is unsafe, Brenlo reserves the right to defer delivery of the products ordered.

PAYMENT AND CREDIT

For all non-trade account orders, a non-refundable deposit is required to process the order. For prepaid and COD orders, Brenlo accepts company cheques, Visa, and Master card. To set up a trade account, a credit application must be submitted to our credit department for approval. All orders for in stock and custom items shall be C.O.D. until credit is approved.

NOTE: ALL PRODUCTS SOLD BY BRENLO LTD CUSTOM WOOD MOULDINGS WILL REMAIN THE PROPERTY OF BRENLO LTD. CUSTOM WOOD MOULDINGS UNTIL PAID IN FULL.

WARRANTY AND RETURNS

Unusable, defective**, or damaged material to be returned, replaced or credited must be identified and reported to Brenlo Ltd Custom Wood Mouldings within 48 hours of delivery. Brenlo is not responsible for any damage caused after delivery on the job site caused by handling, improper storage, and installation or finishing by the customer.

With prior approval from Brenlo and a product return authorization, Brenlo accepts and will credit any excess returned standard stock product or material that is undamaged and in full resalable condition. Returns of any non-door-related material less than 6' in length will not be eligible for credit. We charge a restocking fee to cover the pick-up and handling that is required.

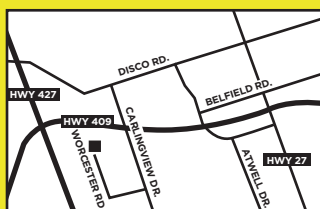

CONTACT INFO:

65 Worcester Rd. Etobicoke, ON M9W 5N7

T 416.749.6857 F 416.749.8969

T/F 877.816.6607

SHOWROOM HOURS:

Monday - Friday 7:30am to 4:30pm

SALES INQUIRY:

sales@brenlo.ca

WWW.BRENLO.COM



The mark of responsible forestry



Follow us on social media!



Follow us on
Instagram